

# **3Ts for Reducing Lead** **in Drinking Water** **in Schools**



***Revised Technical Guidance***

This October 2006 version of the 3Ts for Reducing Lead in Drinking Water in Schools: Revised Technical Guidance is a modification of the December 2005 version. The modifications in this version clarify the instructions for collecting samples from drinking water outlets, please see sections 4.2, 4.4.1, and 4.4.2. Additionally, EPA made some minor modifications to the nomenclature in Chapter 4. Please visit [www.epa.gov/safewater/schools](http://www.epa.gov/safewater/schools) for the complete Errata sheet.

## Disclaimer

---

This manual contains recommendations on how to address lead in school drinking water systems; these are suggestions only and are not requirements. This manual does, however, also contain an overview of requirements concerning lead in drinking water. The statutory provisions and regulations described in this document contain binding requirements. The general description here does not substitute for those laws or regulations; nor is this document a regulation itself. As a result, you will need to be familiar with the details of the rules that are relevant to your school drinking water; you cannot rely solely on this guidance for compliance information. Also, many states (or tribes) and localities have different, more stringent requirements than EPA's, so you will need to find out what other laws and regulations apply to school drinking water in addition to the ones described here.

# 3Ts for Reducing Lead in Drinking Water in Schools: Revised Technical Guidance

## Contents

<b>Introduction</b> .....	4
<b>I. Training</b> .....	6
1. <b>What You Should Know about Lead in Drinking Water</b> .....	6
1.1 Health Effects of Lead .....	6
1.2 Sources of Lead .....	6
1.3 How Lead Gets into Drinking Water .....	7
1.4 How Lead in Drinking Water is Regulated .....	11
2. <b>Planning Your Program and Establishing Partnerships</b> .....	13
2.1 Assigning Roles .....	13
2.2 School Records .....	13
2.3 Establishing Partnerships .....	13
2.3.1 Assistance from Your Public Water Supplier .....	13
2.3.2 Assistance from Your Local Health Office .....	15
2.3.3 Assistance from Your State Drinking Water Program .....	15
2.3.4 Assistance from Certified Laboratories .....	15
2.3.5 Assistance from Local Community Organizations .....	16
<b>II. Testing</b> .....	17
3. <b>Assessment and Strategy: Plumbing Profile and Sampling Plan</b> .....	17
3.1 Development of a Plumbing Profile for Your Facility's Plumbing .....	17
3.2 Who Should Create the Sampling Plan? - Leadership in Sampling .....	24
3.3 Where Should I Sample? - Determining Sample Locations .....	24
3.4 Who Should Collect the Samples and Where Do Samples Go for Analysis? Collection and Analysis of Samples .....	25
4. <b>Conducting Sampling</b> .....	28
4.1 General Sampling Procedures .....	28
4.2 Collection Procedures .....	28
4.3 Laboratory Analysis and Handling of Sample Containers .....	29
4.4 Overview of the Two-Step Sampling Process .....	29
4.4.1 Step 1: Initial Sampling .....	29
4.4.2 Step 2: Follow-Up Sampling .....	30
4.4.3 Initial and Follow-Up Sampling Protocol .....	33
4.4.4 Sampling for Other Parameters .....	36

<b>5. Remedies</b> .....	55
5.1 Routine Control Measures .....	55
5.2 Interim (Short-Term) Control Measures .....	55
5.3 Permanent Remedies .....	57
<b>III. Telling</b> .....	65
<b>6. Informing the Public about Lead</b> .....	65
6.1 Techniques for Disseminating Public Information .....	65
6.2 The Components of an Effective General Communication Strategy .....	66
6.3 Participants .....	66
6.4 Timing .....	67
6.5 Content .....	67
6.6 Methods and Manner of Communication .....	67
6.7 Sample Public Notice Materials .....	68
<b>Appendix A – Glossary of Terms</b> .....	73
<b>Appendix B – Publication List</b> .....	75
<b>Appendix C – Resources</b> .....	77
<b>Appendix D – List of State Drinking Water Programs</b> .....	78
<b>Appendix E – Water Cooler Summary</b> .....	86
<b>Appendix F – Sample Recordkeeping Form</b> .....	89
<b>Appendix G – Preservation of Samples and Sample Containers</b> .....	90
<b>Appendix H – Example Scenarios for Water Sample Results</b> .....	91
<b>Appendix I – Plumbing Profile Questionnaire</b> .....	96

## Exhibits

---

Exhibit 1.1:	Potential Sources of Lead in Schools .....	9
Exhibit 1.2:	Common Drinking Water Outlets .....	10
Exhibit 3.1:	Sample Plumbing Profile Questionnaire .....	18
Exhibit 3.2:	Plumbing Configuration for a Single-Level Building .....	26
Exhibit 3.3:	Plumbing Configuration for a Multi-Level Building .....	27
Exhibit 4.1:	Pipe Volumes for Copper Pipe .....	34
Exhibit 4.2:	Sample Strategy Flowchart .....	35
Exhibit 4.3:	Service Connection Sampling .....	37
Exhibit 4.4:	Drinking Water Fountains: Bubblers .....	39
Exhibit 4.5:	Drinking Water Fountains: Water Coolers .....	41
Exhibit 4.6:	Drinking Water Fountains: Bottled Water Dispensers .....	45
Exhibit 4.7:	Ice Making Machines .....	46
Exhibit 4.8:	Water Faucets (Taps) .....	47
Exhibit 4.9:	Sampling Interior Plumbing .....	48
Exhibit 4.10:	Sample Sites for a Single-Level Building .....	53
Exhibit 4.11:	Sample Sites for a Multi-Level Building .....	54
Exhibit 5.1:	Flushing Directions by Outlet Type .....	56
Exhibit 5.2a:	Remediation Flow Chart (part 1) .....	60
Exhibit 5.2b:	Remediation Flow Chart (part 2) .....	61
Exhibit 5.2c:	Remediation Flow Chart (part 3) .....	62
Exhibit 5.3:	Case Study 1 .....	63
Exhibit 6.1:	Sample Public Notice Letter .....	69
Exhibit 6.2:	Sample Press Release for Local Media .....	70
Exhibit 6.3:	Sample Newsletter Article .....	71

## Introduction

The Environmental Protection Agency (EPA) developed this guidance manual because the Agency is concerned about the potential for elevated lead levels in drinking water in schools. Children are most susceptible to the effects of lead, because their bodies are still undergoing development. The adverse health effects from lead include reduced IQ and attention span, learning disabilities, poor classroom performance, hyperactivity, behavioral problems, impaired growth, and hearing loss.

There is no federal law requiring testing of drinking water in schools, except for schools that have their own water supply and are thus regulated under the Safe Drinking Water Act (SDWA). The vast majority of public water suppliers do not include schools in their sampling plans because regulations (specifically the Lead and Copper Rule) require sampling of single family dwellings. States and local jurisdictions may, however, establish their own programs for testing drinking water lead levels in schools. EPA suggests that schools implement programs for reducing lead in drinking water as part of the school's overall plan for reducing environmental threats. Safe and healthy school environments foster healthy children, and may improve students' general performance.

Lead most frequently gets into drinking water by leaching from plumbing materials and fixtures as water moves through your school's distribution system. Even though the drinking water you receive from your water supplier meets federal and state standards for lead, your facility may have elevated lead levels due to plumbing materials and water use patterns. Because lead concentrations can change as water moves through the distribution system, the best way to know if a school might have elevated levels of lead in its drinking water is by testing the water in that school. Testing facilitates an evaluation of the plumbing and helps target remediation. It is a key step in understanding the problem, if there is one, and designing an appropriate response.

This guidance manual is intended for use by school officials responsible for the maintenance and/or safety of school facilities including the drinking water. The guidance introduces the 3Ts for reducing lead in drinking water. The 3Ts are:

- ▶ **Training** school officials to raise awareness of the potential occurrences, causes, and health effects of lead in drinking water; assist school officials in identifying potential areas where elevated lead may occur; and establishing a testing plan to identify and prioritize testing sites.
- ▶ **Testing** drinking water in schools to identify potential problems and take corrective actions as necessary.
- ▶ **Telling** students, parents, staff, and the larger community about monitoring programs, potential risks, the results of testing, and remediation actions.

The purpose of this manual is to help schools minimize their students' and staff's exposure to lead in drinking water. This manual is specifically targeted at schools that receive water from water utilities or water suppliers such as cities, towns and water districts. This guidance manual replaces the 1994 EPA guidance document *Lead in Drinking Water in Schools and Non-Residential Buildings*. By following the steps below, you will be assured your facility does not have elevated levels of lead in the drinking water.

## Training

---

- (1) Conduct a thorough review of this guidance document. Other reference documents are available. See Appendix B.
- (2) Review available resources to find out what may already have been done and what assistance may be available to you. See Chapter 2.
- (3) Develop a plumbing profile to assess the factors that contribute to lead contamination. See Chapter 3.
- (4) Develop a drinking water sampling plan. See Chapter 3.

## Testing

---

- (5) Test the water. See Chapter 4.
- (6) Correct any problems that are identified. See Chapter 5.

## Telling

---

- (7) Communicate to students, parents, staff, and the larger community about what you are doing to protect them from possible exposure to lead in drinking water. See Chapter 6.



# **I. Training**

## **1. What You Should Know about Lead in Drinking Water**

---

### **1.1 Health Effects of Lead**

Lead is a toxic metal that is harmful to human health. Lead has no known value to the human body. The human body cannot tell the difference between lead and calcium, which is a mineral that strengthens the bones. Like calcium, lead remains in the bloodstream and body organs like muscle or brain for a few months. What is not excreted is absorbed into the bones, where it can collect for a lifetime.

Young children, those 6 years and younger, are at particular risk for lead exposure because they have frequent hand-to-mouth activity and absorb lead more easily than do adults. Children's nervous systems are still undergoing development and thus are more susceptible to the effects of toxic agents. Lead is also harmful to the developing fetuses of pregnant women.

No safe blood lead level in children has been determined. Lead can affect almost every organ and system in your body. The most sensitive is the central nervous system (brain), particularly in children. Lead also damages kidneys and the reproductive system. The effects are the same whether it is breathed or swallowed. Low blood levels of lead (those below 10 µg/dL) have been associated with reduced IQ and attention span, learning disabilities, poor classroom performance, hyperactivity, behavioral problems, impaired growth, and hearing loss. Very high lead level (blood lead levels above 70 µg/dL) can cause severe neurological problems such as coma, convulsions, and even death. The only method to determine a child's lead level is for them to have a blood lead test done by a health provider.

The degree of harm from lead exposure depends on a number of factors including the frequency, duration, and dose of the exposure(s) and individual susceptibility factors (e.g., age, previous exposure history, nutrition, and health). In addition, the degree of harm depends on one's total exposure to lead from all sources in the environment - air, soil, dust, food, and water. Lead in drinking water can be a significant contributor to overall exposure to lead, particularly for infants whose diet consists of liquids made with water, such as baby food, juice, or formula.

### **1.2 Sources of Lead**

Lead is distributed in the environment through both natural and man-made means. Today, the greatest contributions of lead to the environment stem from past human activities. Sources of lead exposure include the following:

- (1) **Lead based paint.** The most common sources of lead exposure for children are chips and particles of deteriorated lead paint. Although children may be exposed to lead from paint directly by swallowing paint chips, they are more often exposed by house dust or soil contaminated by leaded paint. Lead paint chips become ground into tiny bits that become part of the dust and soil in and around homes. This usually occurs when leaded paint deteriorates or is subject to friction or abrasion (as on doors and windowsills and window wells). In addition, lead can be dispersed when paint is disturbed during demolition, remodeling, paint removal, or preparation of painted surfaces for repainting.



- (2) **Lead in the air.** Lead in the air comes from industrial emissions.
- (3) **Lead in soil.** Lead deposits in soils around roadways and streets from past emissions by automobiles using leaded gas, together with paint chips and lead paint dust.
- (4) **Lead industry.** Byproducts brought home by industrial workers on their clothes and shoes.
- (5) **Lead in consumer products and food.** Lead may be found in some imported candies, medicines, dishes, toys, jewelry, and plastics.
- (6) **Lead in water.** Lead in water occurs through corrosion of plumbing products containing lead.

The U.S. government has taken steps over the past several decades to dramatically reduce new sources of lead in the environment: by banning the manufacture and sale of leaded paint; by phasing out lead additives in gasoline, and by encouraging the phase-out of lead seams in food cans; by banning the sale of pipes and plumbing for drinking water that are not “lead-free”; and by banning lead-lined water coolers, among other activities. More recently, the government has begun to address persistent sources of lead in the environment. For example, programs have been instituted to minimize the hazards posed by lead paint covering millions of homes across the United States, more stringent air control standards are being applied to industries emitting lead, and more stringent regulations are in place to control lead in drinking water. Regulations affecting lead in drinking water are described at the end of this chapter.

### 1.3 How Lead Gets into Drinking Water

Lead can get into drinking water in two ways:

- (1) by being present in the source water, such as coming from contaminated runoff or water pollution.
- (2) through an interaction between the water and plumbing materials containing lead, such as through corrosion.

#### (1) At the Source

Most sources of drinking water have no lead or very low levels of lead (i.e., under 5 parts per billion). However, lead is a naturally occurring metal and in some instances can get into well water. Lead can enter surface waters (waters from rivers, lakes, or streams) through direct or indirect discharges from industrial or municipal wastewater treatment plants or when lead in air settles into water or onto city streets and eventually, via rain water, flows into storm sewers, or waterways, which may enter the water supply. Lead from these sources can be easily removed by existing treatment plant technologies.

#### (2) Through Corrosion

Most lead gets into drinking water after the water leaves the local well or treatment plant and comes into contact with plumbing materials containing lead. These include lead pipe and lead solder (commonly used until 1986) as well as faucets, valves, and other components made of brass. The physical/chemical interaction that occurs between the water and plumbing is referred to as corrosion. The extent to which corrosion occurs contributes to the amount of lead that can be released into the drinking water.

The *critical issue* is that even though your public water supplier may deliver water that meets all federal and state public health standards for lead, you may end up with too much lead in your drinking water because of the plumbing in your facility. The potential for lead to leach into water can increase the longer the water

remains in contact with lead in plumbing. **As a result, facilities with intermittent water use patterns, such as schools, may have elevated lead concentrations. Testing drinking water in schools is important because children spend a significant portion of their day in these facilities and are likely to consume water while they are there.** That is why testing water from your drinking water outlets for lead is so important. Drinking water outlets are locations where water may be used for consumption, such as a drinking fountain, water faucet, or tap.

The corrosion of lead tends to occur more frequently in “soft” water (i.e., water that lathers soap easily) and acidic (low pH) water. Other factors, however, also contribute to the corrosion potential of the water and include water velocity and temperature, alkalinity, chlorine levels, the age and condition of plumbing, and the amount of time water is in contact with plumbing. The occurrence and rate of corrosion depend on the complex interaction between a number of these and other chemical, physical, and biological factors.

As illustrated in Exhibit 1.1, once the water leaves the public water supply system or treatment plant, drinking water comes into contact with plumbing materials that may contain lead. Some lead may get into the water from the distribution system – the network of pipes that carry the water to homes, businesses, and schools in the community. Some communities have lead components in their distribution systems, such as lead joints in cast iron mains, service connections, pigtails, and goosenecks. These components may or may not be owned by your water supplier.

Sediments containing lead may also collect in the low-lying sections of pipe or behind sediment screens. Lead-containing sediments may result from minute particles of pipe, mineral deposits (scales), valves, fixtures, solder, or flux that accumulate in the plumbing. This may happen during the initial construction of the plumbing system, during repairs, when connecting new fixtures, when plumbing is otherwise disturbed, or during normal use (e.g., turning of faucet handles, movement of valves, etc.). Sediment can also originate from the public water system’s water mains and service taps.

If the public water supplier finds unacceptable levels of lead at customers’ homes, the system may have to provide centralized treatment to minimize the corrosion of lead into the water (see “How Lead in Drinking Water is Regulated” in section 1.4). However, centralized treatment by a public water system does not guarantee that corrosion of lead from plumbing will not occur within buildings served by the public water system, i.e., your school.

Interior plumbing, soldered joints, leaded brass fittings, and various drinking water outlets that contain lead materials are the primary contributors of lead in drinking water. It is also important to note that brass plumbing components contain lead. Examples of some of the common drinking water outlets are shown in Exhibit 1.2. (The glossary in Appendix A provides definitions of the various drinking water outlets discussed in this document.) Although there is an increased probability that a given plumbing component installed prior to the 1990s could contain more lead than the newer components, *the occurrence of lead in drinking water can not be predicted based upon the age of the component or the school facility.*

### Exhibit 1.1: Potential Sources of Lead in Schools

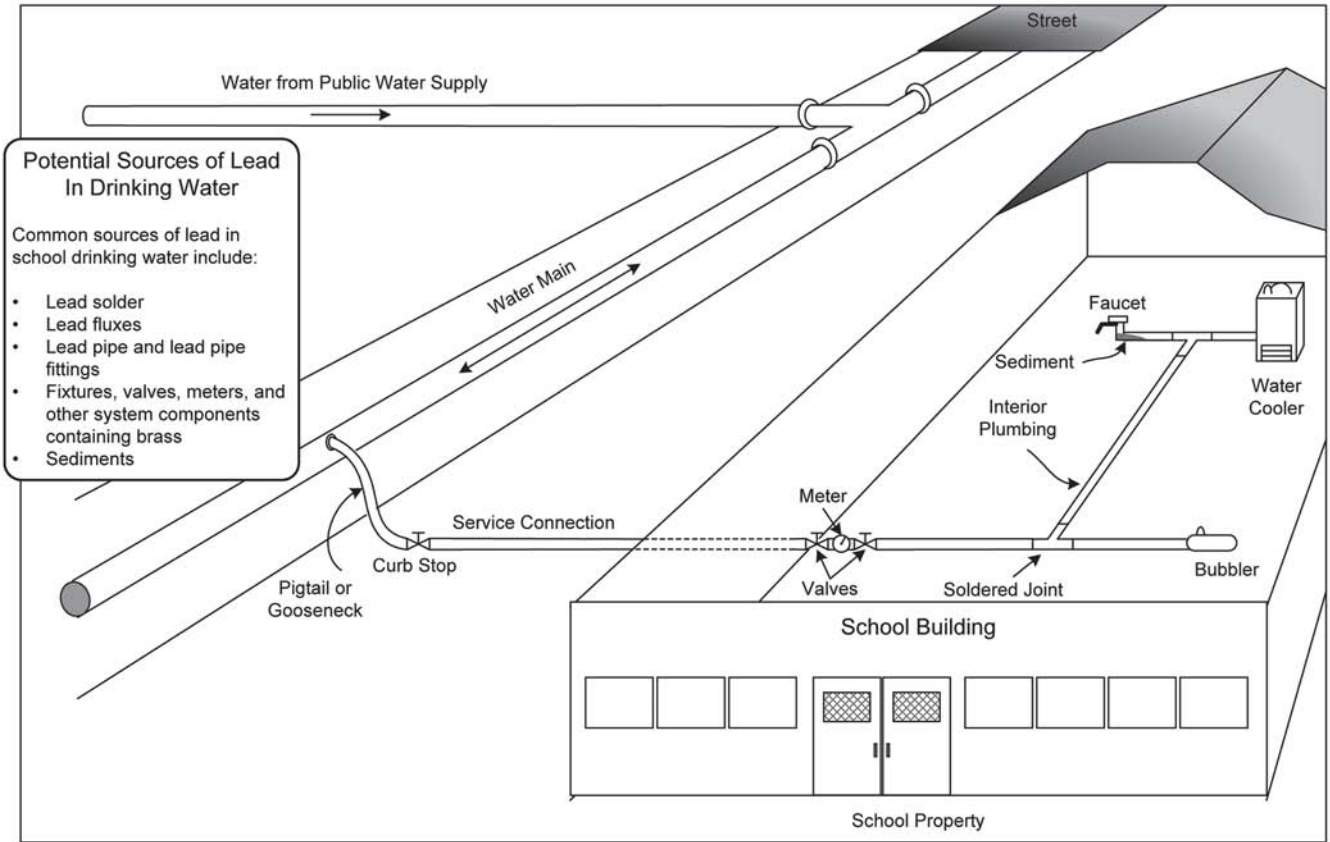

### Exhibit 1.2: Common Drinking Water Outlets

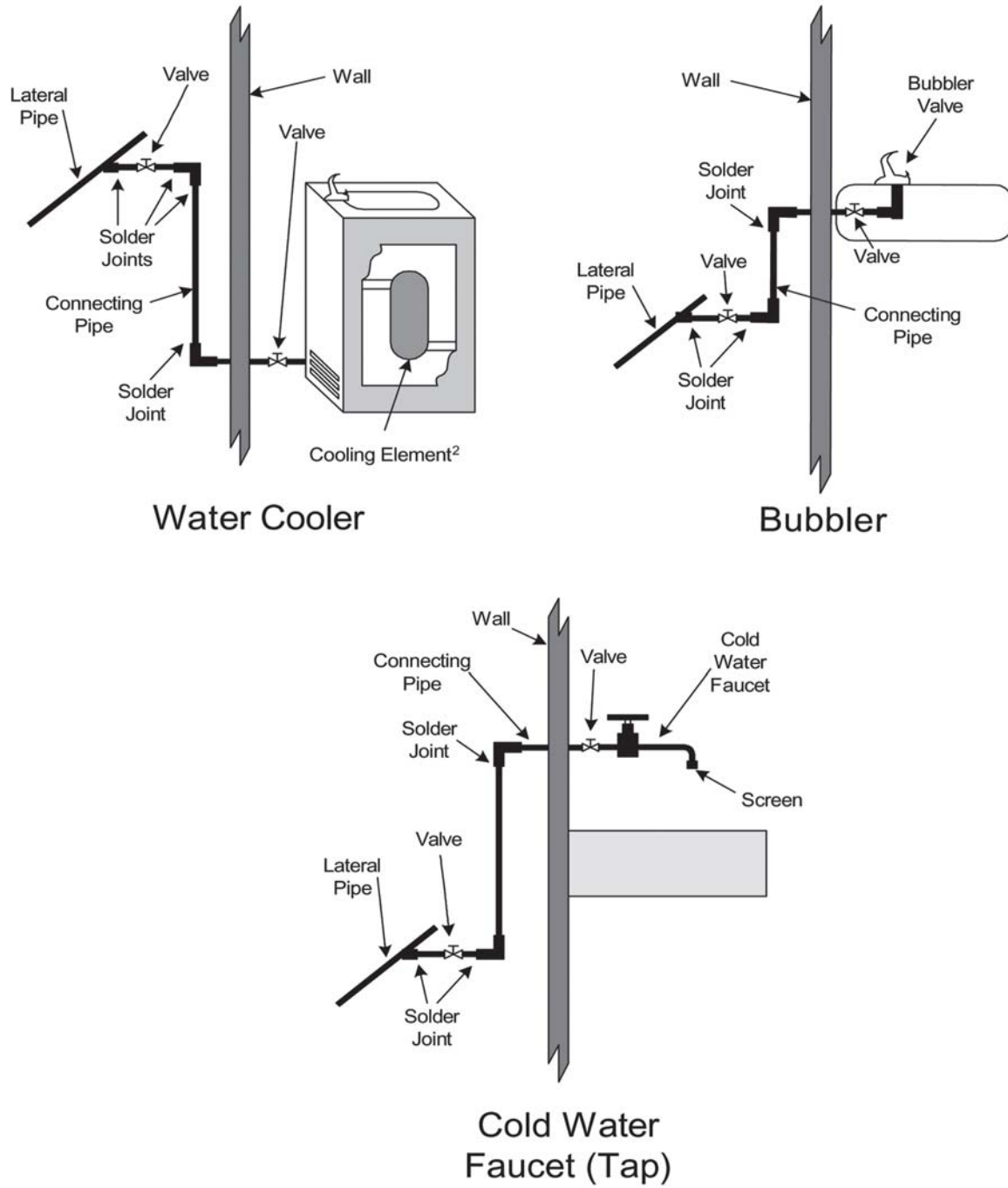

<sup>1</sup>Valve locations are approximate and will vary, depending upon installation.

<sup>2</sup>Old cooling elements may be lead-lined. For more information on replacement of lead-lined cooling elements, see Appendix E of this document.

## 1.4 How Lead in Drinking Water is Regulated

Lead is regulated in public drinking water supplies under a federal law known as the Safe Drinking Water Act (SDWA). This Act was initially passed in 1974 and, in part, requires EPA to establish regulations for known or potential contaminants in drinking water for the purpose of protecting public health.

The requirements developed by EPA apply to **public water systems**. *Schools that are served by a public water system* (i.e., a drinking water system that they do not own or operate) are not subject to the SDWA monitoring and treatment requirements, because those schools do not meet the definition of a public water system. However, some states may have monitoring and treatment requirements for these schools. Nearly all states have a drinking water office that implements the SDWA on behalf of EPA. Questions regarding the regulation of your drinking water may be directed to the appropriate state drinking water program office (see Appendix D for a directory of state programs).

Additional requirements under the Safe Drinking Water Act include specific provisions for controlling lead in drinking water:

- ▶ **THE LEAD BAN (1986):** A requirement that only lead-free materials be used in new plumbing and in plumbing repairs.
- ▶ **THE LEAD CONTAMINATION CONTROL ACT (LCCA) (1988):** The LCCA further amended the SDWA. The LCCA is aimed at the identification and reduction of lead in drinking water at schools and child care facilities. However, implementation and enforcement of the LCCA has been at each state's discretion. School monitoring and compliance has varied widely.
- ▶ **THE LEAD AND COPPER RULE (1991):** A regulation by EPA to minimize the corrosivity and amount of lead and copper in water supplied by public water systems.

The table below summarizes the significant elements of the SDWA with respect to lead in drinking water. Note that the 1991 Lead and Copper Rule *does not apply to schools that receive water from a public water system*.

## REQUIREMENTS UNDER THE SAFE DRINKING WATER ACT

- **The 1986 SDWA Lead Ban.** This provision of the SDWA requires the use of “lead-free” pipe, solder, and flux in the installation or repair of any public water system or any plumbing in a residential or non-residential facility providing water for human consumption. Solders and flux are considered to be lead-free when they contain less than 0.2 percent lead. Before this ban took effect on June 19, 1986, solders used to join water pipes typically contained about 50 percent lead. Pipes and pipe fittings are considered “lead-free” under the Lead Ban when they contain less than 8 percent lead. Plumbing fixtures that are not “lead-free” were banned from sale after August 6, 1998. Plumbing fixtures are subject to the NSF International standard.

*NOTE: “Lead-free” pipe is allowed to contain up to 8 percent lead and “lead-free” solder and flux may contain up to 0.2 percent lead. Lead-free plumbing components are not necessarily “free” of lead.*

- **The 1988 Lead Contamination Control Act (LCCA).** The purpose of the LCCA is to reduce lead exposure and the health risks associated with it by reducing lead levels in drinking water at schools and child care centers. The LCCA created lead monitoring and reporting requirements for all schools, and required the replacement of drinking water fixtures that contained excessive levels of lead (see Appendix E for a listing of these fixtures). The provisions are not enforceable. As a result, states have the option to voluntarily enforce the provisions of the Act (or alternate provisions) through their own authority.
- **The 1991 Lead and Copper Rule (LCR).** The LCR requires public water suppliers to monitor for lead in drinking water and to provide treatment for corrosive water if lead or copper are found at unacceptable levels. EPA strongly recommends that schools test their facilities for lead. However, unless a school owns its water system, testing for lead and copper within the school is not specifically required. Therefore, many schools served by water systems owned by cities, towns, or other entities may have never been tested for lead under the LCR.

## PUBLIC WATER SUPPLY TESTING VS. TESTING AT SCHOOLS

(15 ppb vs 20 ppb)

- It is important to note that the lead testing protocol used by public water systems is aimed at identifying system-wide problems rather than problems at outlets in individual buildings. Moreover, the protocols for sample size and sampling procedures are different. Under the LCR for public water systems, a lead action level of 15 parts per billion (ppb) is established for 1 liter samples taken by public water systems at high-risk residences. If more than 10 percent of the samples at residences exceed 15 ppb, system-wide corrosion control treatment may be necessary. The 15 ppb action level for public water systems is therefore a trigger for treatment rather than an exposure level.
- EPA recommends that schools collect 250 mL first-draw samples (i.e., samples of stagnant water before any flushing or use occurs) from water fountains and other outlets used for consumption, and that the water fountains and/or outlets be taken out of service if the lead level exceeded 20 ppb. The sample was designed to pinpoint specific fountains and outlets that require remediation (e.g. water cooler replacement). The school sampling protocol maximizes the likelihood that the highest concentrations of lead are found because the first 250 mL are analyzed for lead after overnight stagnation.

## 2. Planning Your Program and Establishing Partnerships

---

Monitoring for lead in your school's drinking water is extremely important. If you have never or have not recently monitored for lead in your school's drinking water, you are encouraged to begin the process by identifying any lead problems that you may have in your drinking water. You should start by identifying your existing resources, which include school records, available finances, and personnel. You should also research opportunities for assistance from your local public water supplier, state and local health agencies, and certified water testing laboratories.

### 2.1 Assigning Roles

Your school should assign responsibility to a key individual(s) to ensure that testing and follow-up actions are completed. A person should also be appointed to serve as the contact person for communication with interested parties (civic groups, the media, etc.). One person or more may be involved in these activities, but it is important to clearly define responsibilities and to support those people in their roles. An effective program will require a team effort.

If your school decides to use consultants or lab personnel, their roles should be defined with respect to the responsible person(s) at the school. Contact your state drinking water program or local health department if you need advice on how to identify a qualified consultant.

### 2.2 School Records

To determine if previous monitoring efforts have been made at your school, you should review your school records. Some schools conducted voluntary monitoring in cooperation with state or local officials in response to the 1988 Lead Contamination Control Act (LCCA). Other schools may have sampled for lead in response to state requirements. This information will be useful in filling out your Plumbing Profile Questionnaire (see Chapter 3), a tool that may be used to help determine whether lead is likely to be a problem in your facility. Records should also be reviewed to determine whether remediation actions have been taken. For example, have water coolers that contain lead been replaced (see Appendix E for a listing of banned water coolers)? While these records may not make additional testing or remediation unnecessary, they will help to prioritize your efforts and make them more efficient.

If testing or remediation was conducted in response to the 1988 Lead Contamination Control Act, it may have taken place 10 years ago or more. If you are not familiar with what activities may have taken place at your school and your records are incomplete or absent, you are encouraged to contact individuals that may have been involved in the past. Personnel that were involved may remember activities that were not well-documented. They may also remember whether other agencies or the local public water supplier were involved, which may mean that additional records are available.

### 2.3 Establishing Partnerships

#### 2.3.1 Assistance from Your Public Water Supplier

Some public water suppliers have devoted resources to helping schools conduct testing for lead even though they may not be legally required to do so. As discussed in the previous chapter, public water suppliers are



required by the Lead and Copper Rule to monitor for lead at customers' taps. However, testing at schools was not specifically required unless the public water system was owned and operated by the school. Therefore, unless a school served by a public water system tested for lead on its own, or had testing voluntarily conducted by the public water system, neither the school nor the public water system is likely to have any record of testing. Although the public water system may treat the water to minimize corrosion, it is very important that you test to determine to what extent lead is leaching from plumbing within the school.

You are encouraged to contact your public water supplier to determine whether assistance or information on previous efforts is available. Although utilities are under no obligation to do so, assistance may be available through technical guidance, sampling, or sharing in sampling costs. Some utilities may be willing to help develop sampling plans (see Chapter 3) and plumbing profiles (see Chapter 3). The American Water Works Association (AWWA), a non-profit organization of water system professionals, recently prepared a summary of information for water suppliers on options for providing assistance to schools.

You should obtain the results of your water supplier's required monitoring under the Lead and Copper Rule to determine whether they are in compliance with the requirements of the Lead and Copper Rule. Your water utility should be able to tell you whether lead monitoring is current, whether the monitoring results are below the lead action level, and whether corrosion control treatment is provided. Your water supplier should also be able to tell you whether they have conducted lead monitoring at your school, and they may be able to give you some indication of whether lead could be a problem within your building(s).

You may wish to begin by contacting your local director of public works, water superintendent, or water department, depending upon how your utility is organized. Some utilities have Web sites with contact information. All public water suppliers are required to produce and distribute an annual Consumer Confidence Report (CCR). You may want to get in the habit of thoroughly reviewing your utility's CCR for important information about the water chemistry and overall water quality. Changes in water chemistry or quality may affect your school's long-term sampling plan. The CCR also provides the name(s) and contact information for those at your utility who may be able to answer any questions you have.

### Questions to Ask Your Drinking Water Supplier

It is important to know who supplies your facility's drinking water, and whether and how the water entering your facility is treated. Some kinds of treatment can make the water more corrosive, while others will reduce the problem. If the water is corrosive, treatment can reduce lead levels throughout the system and can save you and the supplier money by reducing damage to plumbing. The following are some questions you may want to ask your public water supplier:

- Ask for a copy of the most recent annual water quality report (CCR).
- Is the water system in compliance with federal and state standards for lead monitoring and treatment?
- What steps have been taken to maintain compliance with the Lead and Copper Rule?
- Does the utility have sample results from the school?
- Is the water corrosive? If so, what is the system doing to minimize corrosion?
- If a corrosion control chemical is used, does the chemical form a protective coating inside the piping?
- Does the water distribution system have any lead piping (for example, lead gooseneck at service connections), and does the system plan to remove these sources of lead?

### 2.3.2 Assistance from Your Local Health Office

Many local governments have established programs that are responsible for a wide variety of public health protection activities, such as a Lead Poisoning Prevention Program. These programs are often the first line of defense when public health risks arise. Lead programs for children are often a high priority for local health offices.

You may wish to contact the local health office to discuss your needs. Although resources may be limited, the office may be willing to provide assistance in a variety of ways. For example, a representative may be able to attend Parent and Teacher Association meetings to discuss potential health effects, as well as to act as a contact with state programs to obtain information and assistance. A representative may even be able to assist in developing the plumbing profile, conducting sampling, or in taking follow-up action.

The phone number for your local health office should be in the listings under your county or city government. Many offices also have a Web site. The following Web site contains information about many local health departments listed by state [http://www.healthguideusa.org/local\\_health\\_departments.htm](http://www.healthguideusa.org/local_health_departments.htm).

### 2.3.3 Assistance from Your State Drinking Water Program

As discussed in Chapter 1, the only federal requirement that applies uniformly to schools that receive water from a public water system is the ban on the installation of water system components that are not lead-free (the Lead Ban).

You are encouraged to contact your state program to determine whether any other requirements apply, or whether technical assistance is available. The drinking water program may be housed in the department of health or the department of the environment. A listing of state program contacts is contained in Appendix D. Most state programs also have Web sites with contact information. The following Web site contains information about many state health departments [http://www.healthguideusa.org/state\\_health\\_departments.htm](http://www.healthguideusa.org/state_health_departments.htm). When discussing the issue with your state program, you may wish to request assistance with voluntary compliance with the Lead Contamination Control Act. Since most state programs are familiar with the Act, this should help to clarify your request.

If you have not been able to make contact with your local public water supplier, you may also wish to ask whether the state program can provide information on monitoring compliance, results, and treatment. Your state program regulates all such water suppliers for compliance with the Lead and Copper Rule, and therefore should have this information readily available.

You may also wish to ask the state drinking water program staff about other state programs that are involved in reducing lead risks for children. There may be an interest in developing a cooperative effort between state programs or between state and local agencies.

### 2.3.4 Assistance from Certified Laboratories

Your state drinking water office should be able to provide a list of certified laboratories in your area. You should only use a laboratory that is certified by the state or EPA for testing lead in drinking water for public water systems.

Some laboratories will provide assistance in addressing the activities described in this manual. For example, some laboratories will collect samples for clients to ensure proper sampling technique and sample preservation. However, costs for services will vary and you may wish to contact several certified labs.

If outside laboratory personnel are used, you should ensure that they understand the testing procedures described in this manual because these procedures differ from those used by public water suppliers for compliance with the Lead and Copper Rule.

### **2.3.5 Assistance from Local Community Organizations**

Your community has a variety of local organizations that can help; for example community volunteer groups, senior citizens groups, the Parent and Teacher Associations, and local environmental groups. Tap into the expertise of people in your community who may be able to help with all aspects of your lead in drinking water reduction program. Another useful resource is your region's Pediatric Environmental Health Speciality Unit (PEHSU). Your region's PEHSU may be able to provide risk communication support to school districts; for more information please visit <http://www.aoec.org/PEHSU.org>.

Contacting these groups is another way for your school to foster support. These groups might be willing to volunteer time to collect samples and train others to collect samples.

## **II. Testing**

### **3. Assessment and Strategy: Plumbing Profile and Sampling Plan**

---

#### **3.1 Development of a Plumbing Profile for Your Facility's Plumbing**

Before testing and correcting lead problems, it is important to target potential problems and to assess the factors that can contribute to lead contamination and the extent to which contamination might occur in your facility. You can best accomplish these objectives by developing a plumbing profile of your facility. If your facility has additions, wings, or multiple buildings built during different years, a separate plumbing profile may be recommended for each. A plumbing profile can be created by answering a series of questions about your facility's plumbing. Every school is unique and a plumbing profile will help you understand the potential sources of lead in your facility. Conducting this survey of your facility's plumbing will enable you to:

- Understand how water enters and flows through your building(s).
- Identify and prioritize sample sites. EPA recommends the following sites as priority sample sites: drinking fountains (both bubbler and water cooler style), kitchen sinks, classroom combination sinks and drinking fountains, home economics room sinks, teachers' lounge sinks, nurse's office sinks, sinks in special education classrooms, and any other sink known to be or visibly used for consumption (e.g., coffeemaker or cups are nearby).
- Understand whether you may have a widespread contamination problem or only localized concerns.
- Plan, establish, and prioritize remedial actions, as necessary.

Exhibit 3.1 provides a plumbing profile questionnaire discussion and interpretations of possible answers designed to help you plan your testing strategy and develop your sampling plan. Planning your strategy will enable you to conduct testing in a cost-efficient manner. For a blank copy of the plumbing profile questionnaire, see Appendix I.

### Exhibit 3.1: Plumbing Profile Questionnaire

Plumbing Profile Questions	What Your Answers to the Plumbing Profile Questions Mean
<p>The questions in this column will help you determine whether lead is likely to be a problem in your facility, and will enable you to prioritize your sampling effort.</p>	<p>This column discusses the significance of possible answers to the plumbing profile questions.</p>
<p>1. When was the original building constructed?</p> <p>Were any buildings or additions added to the original facility? If so, complete a separate plumbing profile for each building, addition, or wing.</p>	<p><b>Older Buildings</b> – Through the early 1900s, lead pipes were commonly used for interior plumbing in certain parts of the country in public buildings and private homes. Plumbing installed before 1930 is more likely to contain lead than newer pipes. Between 1920 and 1950, galvanized pipes were also used for plumbing. After 1930, copper generally replaced lead as the most commonly used material for water pipes. Up until the mid- to late-1980s (until the lead-free requirements of the 1986 Safe Drinking Water Act Amendments took effect), lead solder was typically used to join these copper pipes. The efforts of your public water supplier over the years to minimize the corrosiveness of the water may have resulted in mineral deposits forming a coating on the inside of the water pipes (passivation). This coating insulates the water from the plumbing and results in decreased lead levels in water. If the coating does not exist or is disturbed, the water is in direct contact with any lead in the plumbing system.</p> <p><b>Newer Buildings</b> – New buildings are not likely to have lead pipes in their plumbing systems, but they are very likely to have copper pipes with solder joints. Buildings constructed prior to the late 1980s, before the lead-free requirements of the 1986 Safe Drinking Water Act Amendments, may have joints made of lead solder. Buildings constructed after this period should have joints made of lead-free solders. Even if “lead-free” materials were used in new construction and/or plumbing repairs, lead leaching may occur.</p>

<p>2. If built or repaired since 1986, were lead-free plumbing and solder used in accordance with the lead-free requirements of the 1986 Safe Drinking Water Act Amendments? What type of solder has been used?</p> <p>In some areas of the country, it is possible that high-lead materials were used until 1988 or perhaps even later. Your local plumbing code authority or building inspector may be able to provide guidance regarding when high-lead materials were last used on a regular basis in your area.</p>	<p>The 1986 Amendments to the Safe Drinking Water Act banned plumbing components that contained elevated levels of lead. Lead-free solder and flux (not more than 0.2% lead) and pipe, pipe fittings, and fixtures (not more than 8% lead) must now be used. The leaching potential of lead-free (i.e., tin-antimony) solder is much less than lead solder. The leaching potential of lead-free pipe, pipe fittings, and fixtures is also less, but leaching is still possible.</p> <p>If lead-free materials were not used in new construction and/or plumbing repairs, elevated lead levels can be produced. If the film resulting from passivation does not exist or has not yet adequately formed, any lead that is present is in direct contact with the water.</p>
<p>3. When were the most recent plumbing repairs made (note locations)?</p>	<p>Corrosion occurs (1) as a reaction between the water and the pipes and (2) as a reaction between the copper and solder (metal-to-metal). This latter reaction is known as galvanic corrosion, which can be vigorous in new piping. If lead solders were used in the piping or if brass faucets, valves, and fittings containing alloys of lead were installed (<i>see response to Question 8 below for further discussion of brass</i>), lead levels in the water may be high. After about 5 years, however, this type of reaction (galvanic corrosion) slows down and lead gets into water mainly as a result of water being corrosive. If the water is non-corrosive, passivation is likely to have occurred and to have reduced opportunities for lead to get into the water system.</p> <p>For these reasons, if the building (or an addition, new plumbing, or repair) is less than 5 years old and lead solder or other materials (e.g., brass faucets containing lead alloys) were used, you may have elevated lead levels. If water supplied to the building is corrosive, lead can remain a problem regardless of the plumbing's age.</p>

<p>4. With what materials is the service connection (the pipe that carries water to the school from the public water system's main in the street) made? Note the location where the service connection enters the building and connects to the interior plumbing.</p>	<p>Lead piping was often used for the service connections that join buildings to public water systems. The service connection is the pipe that carries drinking water from a public water main to a building. Some localities actually required the use of lead service connections up until the lead-free requirements of the 1986 Safe Drinking Water Act Amendments took effect. Although a protective layering of minerals may have formed on these pipes, vibrations can cause flaking of any protective build-up and, thus, allow lead contamination to occur.</p>
<p>5. Specifically, what are the potable water pipes made of in your facility (note the locations)?</p> <ul style="list-style-type: none"> <li>• Lead</li> <li>• Plastic</li> <li>• Galvanized Metal</li> <li>• Cast Iron</li> <li>• Copper</li> <li>• Other</li> </ul> <p>Note the location of the different types of pipe, if applicable, and the direction of water flow through the building. Note the areas of the building that receive water first, and which areas receive water last.</p>	<p>Survey your building for exposed pipes, preferably accompanied by an experienced plumber who should be able to readily identify the composition of pipes on site. Most buildings have a combination of different plumbing materials:</p> <ul style="list-style-type: none"> <li>• Lead pipes are dull gray in color and may be easily scratched by an object such as a knife or key. Lead pipes are a major source of lead contamination in drinking water.</li> <li>• Galvanized metal pipes are gray or silver-gray in color and are usually fitted together with threaded joints. In some instances, compounds containing lead have been used to seal the threads joining the pipes. Debris from this material, which has fallen inside the pipes, may be a source of contamination.</li> <li>• Copper pipes are red-brown in color. Corroded portions may show green deposits. Copper pipe joints were typically joined together with lead solders until the lead-free requirements of the 1986 Safe Drinking Water Act Amendments took effect.</li> <li>• Plastic pipes, especially those manufactured abroad, may contain lead. If plastic pipes are used, be sure they meet NSF International standards. (Note: NSF International is an independent, third-party testing organization. Product listings can be obtained by visiting their Web site at <a href="http://www.nsf.org/business/search_listings/index.asp">http://www.nsf.org/business/search_listings/index.asp</a>.)</li> </ul>
<p>6. Do you have tanks in your plumbing system (pressure tanks, gravity storage tanks)?</p> <p>Note the location of any tanks, and any available information about the tank; e.g., manufacturer, date of installation.</p>	<p>Some older tanks may contain coatings that are high in lead content.</p> <p>Tanks may accumulate sediment that could be flushed back into the plumbing system under certain circumstances. You may wish to contact the supplier or manufacturer to obtain information about coatings. You may also wish to hire a plumber or tank service contractor to inspect your tanks, especially gravity storage tanks that are located outside of the building.</p>



<p>7. Was lead solder used in your plumbing system? Note the locations of lead solder.</p>	<p>The 1986 Amendments to the Safe Drinking Water Act banned plumbing components that contained high levels of lead. Lead-free solder and flux (not more than 0.2% lead) must now be used. The leaching potential of lead-free (i.e. tin-antimony) solder is much less than lead solder. It is likely that high-lead solder and fluxes continued to be used until 1988 and even later in some areas of the country. Your local plumbing code authority or building inspector may be able to provide guidance regarding when high-lead solder was last used on a regular basis in your area.</p>
<p>8. Are brass fittings, faucets, or valves used in your drinking water system? (Note: Most faucets are brass on the inside.)</p> <p>You may want to note the locations on a map or diagram of your facility and make extensive notes that would facilitate future analysis of lead sample results.</p>	<p>Brass fittings, faucets, and valves are golden yellow in color, similar to copper in appearance, or are plated with chrome. Brass is composed primarily of two metals, copper and zinc. Most brasses contain lead ranging from 2 percent to 8 percent. That lead can contaminate the water contact surface when it is smeared on the machined surfaces during production. After 1996, brass fittings installed in drinking water outlets such as faucets and water coolers must meet NSF standards for lead content. While this percentage is considered lead-free under the 1986 Safe Drinking Water Act Amendments, some contamination problems still may occur. Older brass faucets may contain higher percentages of lead and lead solder in their interior construction and pose contamination problems. Note that your state or local government may have imposed this standard prior to 1988.</p> <p>The degree to which lead will leach from brass products containing alloys with less than 8 percent lead is dependent upon the corrosiveness of the water and the manufacturing process used to develop the product. A study revealed that fabricated faucets tend to contribute less lead to the water than faucets manufactured by the permanent mold process, regardless of the amount of lead in the alloy.</p> <p>In response to a requirement of the 1996 SDWA, EPA worked with the plumbing industry and NSF International to develop a voluntary industry standard that is designed to minimize the amounts of lead being leached from these products. This standard is NSF/ANSI Standard 61, Section 9. Since 1998, all plumbing fixtures for use as drinking water supply must meet this standard. You should require NSF/ANSI 61 certification on all drinking water system products purchased. Include a copy of the NSF/ANSI 61 certificate as a requirement on your purchase orders. The distributor or manufacturer can provide you with a list of certified products. You should require NSF/ANSI 61 certification on all drinking water system products used in new construction and inform your architects and revise your building specifications.</p>

<p>9. How many of the following outlets provide water for consumption? Note the locations.</p> <ul style="list-style-type: none"> <li>• Water Coolers</li> <li>• Bubblers</li> <li>• Ice Makers</li> <li>• Kitchen Taps</li> <li>• Drinking Fountains or Taps</li> </ul>	<p>In addition to lead components in the plumbing system, lead solders or lead in the brass fittings and valves used in some taps, bubblers, and refrigerated water coolers may be sources of lead. It is important to identify the locations of all such drinking water outlets. Faucets in restrooms should not be used to obtain water for drinking. Although they may be adequate for washing hands, they may not be appropriate for drinking purposes. You may consider posting “do not drink” signs.</p>
<p>10. Has your school checked the brands and models of water coolers and compared them to the listing of banned water coolers in Appendix E? Note the locations of any banned coolers.</p>	<p>Water coolers may be a major source of lead contamination. The Federal Consumer Product Safety Commission negotiated an agreement with Halsey Taylor through a consent order agreement published in June 1990 to provide a replacement or refund program that addresses all the water coolers listed by EPA as having lead-lined tanks. Halsey Taylor was the only company identified by EPA as manufacturing some water coolers with lead-lined tanks. Additionally, some coolers manufactured by EBCO had a bubbler valve and one soldered joint that contained lead.</p> <p>See Appendix E of this manual for a summary of EPA’s list of water coolers found to contain lead. Use the list to help prioritize your sampling. If your water cooler is listed as having a lead-lined tank, you should not use the water for drinking, and you should remove the cooler immediately as these coolers pose the highest risk of contamination.</p>
<p>11. Do outlets that provide drinking water have accessible screens or aerators? (Standard faucets usually have screens. Many coolers and bubblers also have screens.) Note the locations.</p>	<p>Lead-containing sediments that are trapped on screens can be a significant source of lead contamination. Sediments should be tested for the presence of lead, and your facility should create a routine maintenance program to clean the screens frequently. If sediment has been a reoccurring problem regular cleaning of the screens and additional investigating into why the debris is accumulating is appropriate. However, the manufacturer or water service provider should be contacted to obtain instructions.</p>
<p>12. Have these screens been cleaned? Note the locations.</p>	
<p>13. Can you detect signs of corrosion, such as frequent leaks, rust-colored water, or stained dishes or laundry? Note the locations.</p>	<p>Frequent leaks, rust-colored water, and stains on fixtures, dishes, and laundry are signs of corrosive water. Blue-green deposits on pipes and sinks indicate copper corrosion; brown stains result from the corrosion of iron. Where such symptoms occur, high levels of lead, copper, and iron may be present in the water. Lead can accumulate with iron, which can form sediments that are hard to remove.</p>

<p>14. Is any electrical equipment grounded to water pipes? Note the locations.</p>	<p>If electrical equipment, such as telephones, has been installed using water pipes as a ground, the electric current traveling through the ground wire will accelerate the corrosion of any interior plumbing containing lead. The practice should be avoided, if possible. However, if existing wires are already grounded to water pipes, the wires <i>should not be removed</i> from the pipes unless a qualified electrician installs an alternative grounding system. Check with your local building inspector on this matter. Your state or local building code may require grounding of the wires to the water pipes. <b>Improper grounding of electrical equipment may cause severe shock.</b></p>
<p>15. Have there been any complaints about water taste (metallic, etc.) or rusty appearance? Note the locations.</p>	<p>Although you cannot see, taste, or smell lead dissolved in water, the presence of a metallic taste or rusty appearance may indicate corrosion and possible lead contamination.</p>
<p>16. Check building files to determine whether any water samples have been taken from your building for any contaminants (also check with your public water supplier).</p> <ul style="list-style-type: none"> <li>• Name of contaminant(s)?</li> <li>• What concentrations of these contaminants were found?</li> <li>• What was the pH level of the water?</li> <li>• Is testing done regularly at your facility?</li> </ul>	<p>As discussed previously, lead testing may have previously been done voluntarily under the Lead Contamination Control Act. Results of analyses of general water quality, such as measures of pH, calcium hardness, and carbonate alkalinity, can provide important clues about the corrosiveness of the water. Generally, the higher the values of these parameters, the less likely it is that your water is corrosive. If you have no data from your school, your public water system should at least be able to provide information about the general water quality.</p>
<p>17. Other plumbing questions:</p> <ul style="list-style-type: none"> <li>• Are blueprints of the building available?</li> <li>• Are there known plumbing “dead-ends,” low use areas, existing leaks or other “problem areas”?</li> <li>• Are renovations being planned for part or all of the plumbing system?</li> </ul>	<p>You should incorporate this information into decisions regarding sample locations and sampling protocol. You may wish to note the direction of water flow and the location of fixtures, tanks, areas of sediment accumulation, areas of corrosion, etc., on a sketch or blueprint of the plumbing.</p>

Now that you understand the potential dangers of lead contamination in drinking water and the laws and programs in place to address this problem, it is time to begin development of a plumbing profile and a sampling plan.

### 3.2 Who Should Create the Sampling Plan? - Leadership in Sampling

As discussed in Chapter 2, it is important to designate a school employee(s) to take responsibility of the sampling program and follow-up activities, even if someone else is hired to conduct testing. If laboratory representatives or consultants are used to conduct testing, you should ensure that they have experience in conducting lead testing at schools. You may wish to ask the laboratory or consultant for references. Contact your state or local health department or drinking water program if you need advice on how to identify a qualified consultant.

### 3.3 Where Should I Sample? - Determining Sample Locations

You must decide where to take samples and how to prioritize the sample sites based on your responses to the plumbing profile and your knowledge of the facility. If possible, every outlet used for drinking or cooking should be sampled. *At a minimum*, every outlet that is regularly used for cooking and drinking should be sampled. Sample sites that are most likely to have lead contamination include:

- Areas containing lead pipes or lead solder.
- Areas of recent construction and repair in which materials containing lead were used.
- Areas where the plumbing is used to ground electrical circuits.
- Areas of low flow and/or infrequent use.
- Areas containing brass fittings and fixtures.
- Water coolers identified by EPA (See Appendix E) as having lead-lined storage tanks or lead parts. These should be removed.

It may be helpful to diagram the plumbing in your facility and the outlets that will require testing. Examples of plumbing configurations for a single-level building and a multi-level building are illustrated in Exhibits 3.2 and 3.3, respectively. Locate service connections, headers, laterals, loops, drinking water fountains (bubblers and coolers), riser pipes and different drinking water loops (*see Appendix A for a glossary of these plumbing terms*), and decide in what order you wish to take samples.

As shown in the above-mentioned Exhibits, water is carried to the different floors in a multi-level building by one or more riser pipes. Water from the riser pipes is usually distributed through several different drinking water loops. In addition, in some buildings, water may be stored in a tank prior to distribution. In single-story buildings, the water comes from the service connection via main plumbing branches, often called headers. These, in turn, supply water to laterals. Smaller plumbing connections from the laterals and loops supply water to the faucets, drinking water fountains, and other outlets. For sampling purposes, water within a plumbing system moves “downstream” from the source (i.e., from the distribution main in the street through the service connection and through the building).

### 3.4 Who Should Collect the Samples and Where Do Samples Go for Analysis? - Collection and Analysis of Samples

Deciding who will collect samples will be based, in part, on who will analyze the samples. Choosing an individual who is adequately trained to collect samples may help avoid sampling errors. Some state drinking water programs or public water suppliers may provide both services, although there is no federal requirement that they do so. Regardless of who collects the samples, you should employ a certified laboratory to conduct sample analyses. Contact your state drinking water program (Appendix D) or EPA's Safe Drinking Water Hotline (Appendix B and C) for a list of certified laboratories in your area. Consider the following issues prior to making a selection:

- Will the laboratory take samples for you or will they provide training and sample containers for collectors designated by you? (Testing activities can be useless if sample collectors do not follow proper sampling procedures.)
- If it is determined that a laboratory or other consultant will take your samples, make sure they understand the sample protocol. This protocol is described in the next section. *Make sure that laboratories or consultants thoroughly understand this protocol and do not confuse it with the lead testing protocol used by public water suppliers.* The two protocols are different.
- What is the cost of the laboratory's services? Costs will vary, depending upon the extent of the services to be provided (e.g., if only analyses are conducted or if other services such as sample collection are provided). You may want to contact several laboratories to compare prices and services, and you may wish to combine your sampling with another school to obtain a cheaper analysis rate.
- What is the laboratory's time frame for providing sample results?
- Recordkeeping is a crucial activity. *Appendix F contains a sample recordkeeping form and identifies the type of information you should consider recording.*
- Establish a written agreement or contract with the laboratory for all of the services to be provided.

### Exhibit 3.2: Plumbing Configuration for a Single-Level Building

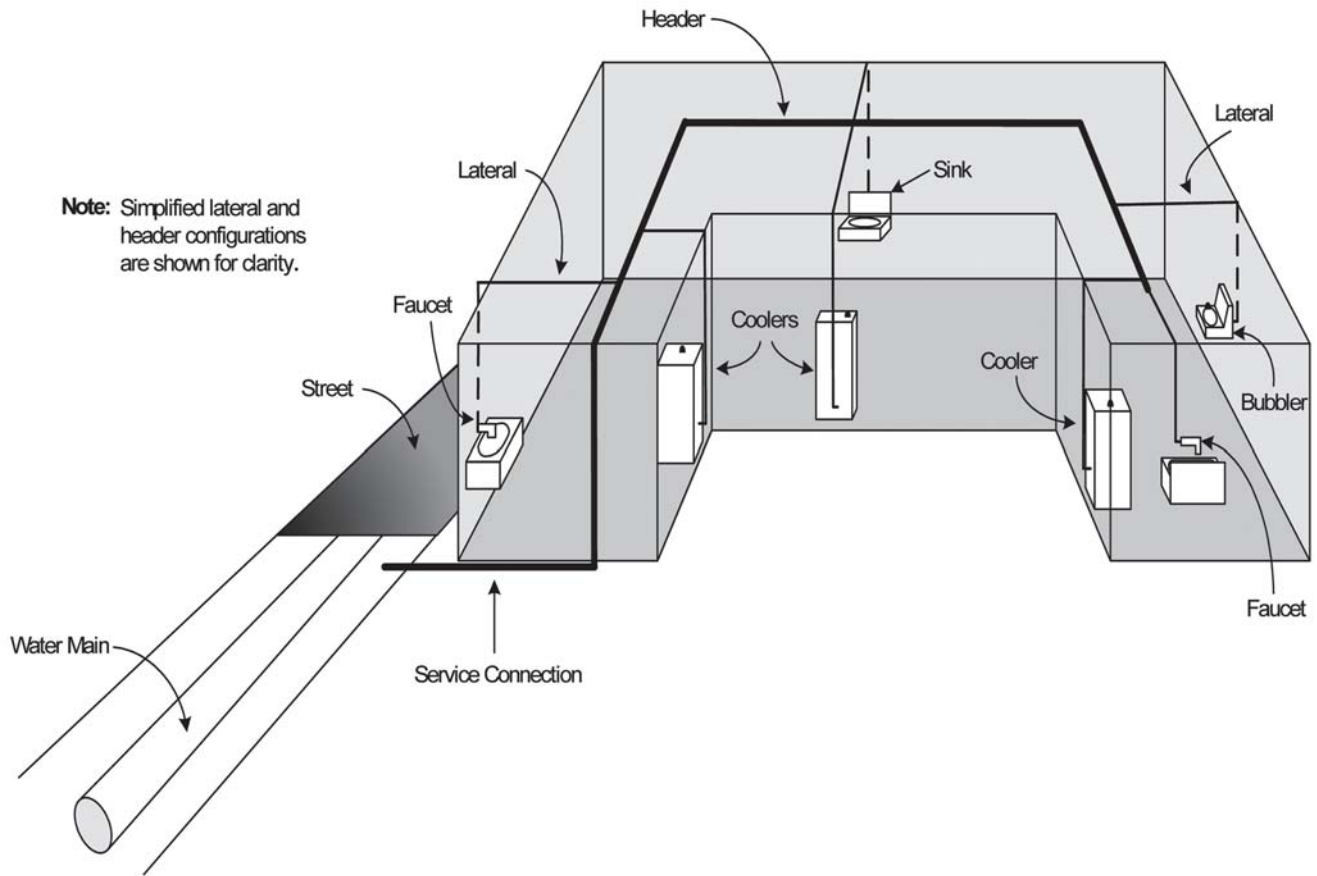

**Exhibit 3.3: Plumbing Configuration for a Multi-Level Building**

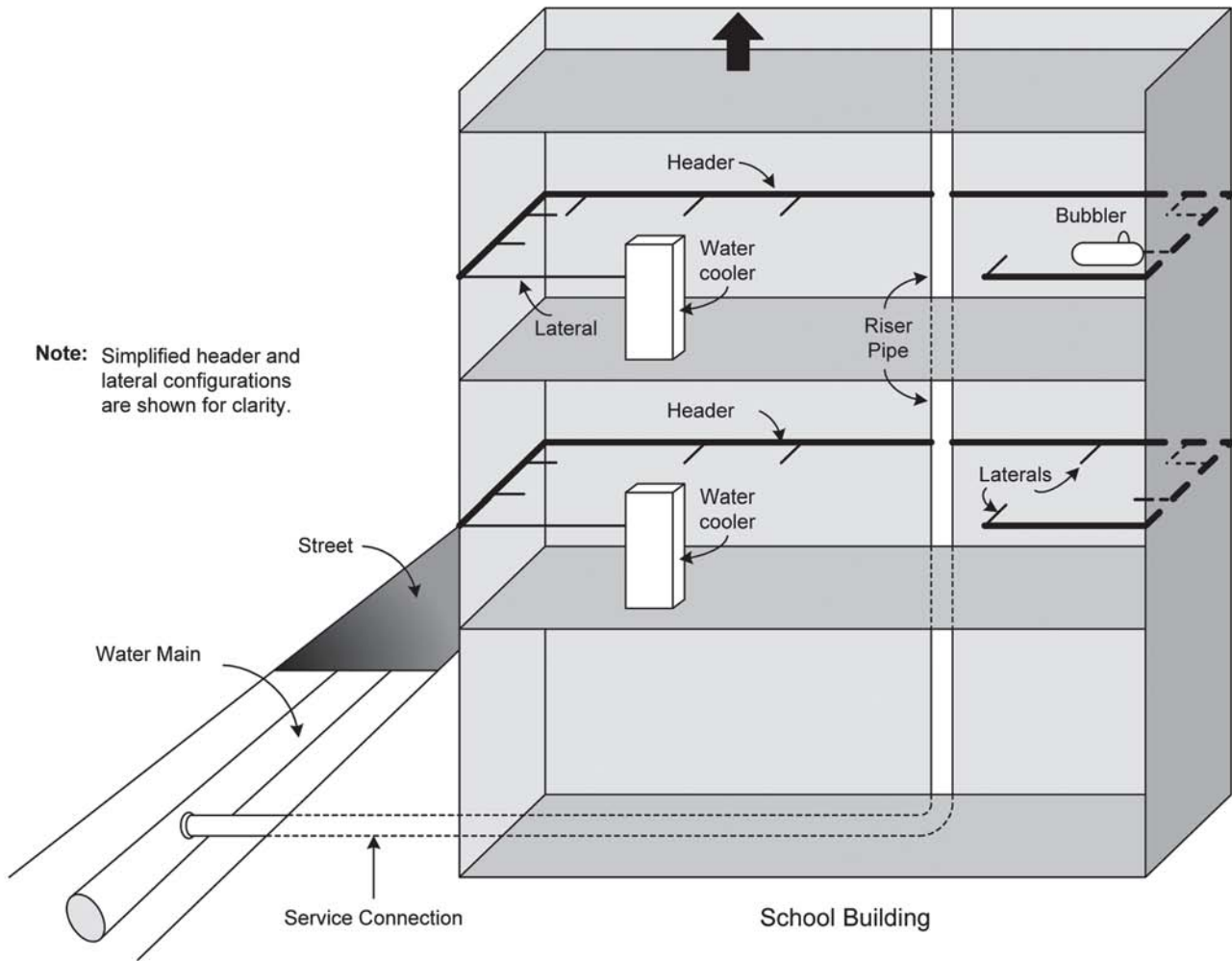



## 4. Conducting Sampling

### 4.1 General Sampling Procedures

This section outlines the general procedures involved in collecting drinking water samples for lead testing, and the two-step sampling process for sampling at your school. Please note that the general two-step sampling process in this chapter contains recommendations for sampling that were created for typical plumbing configurations. If you believe that the recommendations do not fit your specific site conditions, you may wish to modify them as appropriate. See additional discussion in 4.4.3. **EPA strongly recommends that all water outlets in all schools that provide water for drinking or cooking meet a standard of 20 parts per billion (ppb) lead or less.**

### 4.2 Collection Procedures

- (1) All water samples collected should be 250 milliliters (mL) in volume. School samples are smaller than the one liter sample collected by public water suppliers for compliance with the Lead and Copper Rule. A smaller sample is more effective at identifying the sources of lead at an outlet because a smaller sample represents a smaller section of plumbing. A smaller sample is also more representative of water per serving consumed by a child. A 250 mL sample from a faucet would not include portions of the plumbing behind the wall that the faucet is mounted on, for example, compared to a 1000 mL (1 liter) sample, which would include a longer line of plumbing with its valves and tees and elbows and soldered joints.
- (2) Collect all water samples before the facility opens and before any water is used. Ideally, the water should sit in the pipes unused for at least 8 hours but not more than 18 hours before a sample is taken. However, water may be more than 18 hours old at some outlets that are infrequently used. If this is typical of normal use patterns, then these outlets should still be sampled.
- (3) Make sure that no water is withdrawn from the taps or fountains from which the samples are to be collected prior to their sampling.
- (4) Unless specifically directed to do so, do not collect samples in the morning after vacations, weekends, or holidays because the water will have remained stagnant for too long and would not represent the water used for drinking during most of the days of the week.
- (5) Assign a unique sample identification number to each sample collected - use your sampling plan schematic or numbering system. Record the identification number on the sample bottle and on your recordkeeping form (*see Appendix F*). On your recordkeeping form include information on:
  - Type of sample taken, e.g., initial first draw, follow-up flush, etc.
  - Date and time of collection.
  - Name of the sample collector.
  - Location of the sample site.
  - Name of the manufacturer that produced the outlet, and the outlet's model number, if known.

*Consult the sample form in Appendix F for additional recordkeeping items.*

### 4.3 Laboratory Analysis and Handling of Sample Containers

As discussed in the previous chapter, the certified drinking water lab that you select will either collect the samples for you or they will provide you with materials and instructions if you plan to collect your own samples.

If you collect your own samples, follow the instructions provided by the laboratory for handling sample containers to ensure accurate results (*also see Appendix G – Preservation of Samples and Sample Containers*). Make sure the containers are kept sealed between the time of their preparation by the lab and the collection of the sample. Be sure to carefully follow the laboratory's instructions for preservation of the samples. Icing or refrigeration of the samples will likely be necessary. Most laboratories will provide shipping containers and ice packs if shipping is necessary.

When the laboratory returns your test results, the concentrations of lead in your drinking water samples will be reported in metric form such as milligrams per liter (mg/L) or micrograms per liter ( $\mu\text{g/L}$ ), or they will be reported as a concentration such as parts per million (ppm) or parts per billion (ppb), respectively.

Milligrams per liter (mg/L) is essentially the same as parts per million (ppm). Micrograms per liter ( $\mu\text{g/L}$ ) is essentially the same as parts per billion (ppb).

**Examples:** 1 mg/L = 1000  $\mu\text{g/L}$  = 1ppm = 1000ppb; 0.020 mg/L = 20  $\mu\text{g/L}$  = 0.02ppm = 20ppb

### 4.4 Overview of the Two-Step Sampling Process

EPA recommends that a two-step sampling process be followed for identifying lead contamination. Lead in a water sample taken from an outlet can originate from the outlet fixture (the faucet, bubbler etc.), plumbing upstream of the outlet fixture (pipe, joints, valves, fittings etc.), or it can already be in the water that is entering the facility. The two-step sampling process helps to identify the actual source(s) of lead.

In Step 1, initial samples are collected to identify the location of outlets providing water with elevated lead levels and to learn the level of the lead in the water entering the facility (i.e., at the service connection). In Step 2, follow-up flush samples are taken only from outlets identified as problem locations to determine the lead level of water that has been stagnant in upstream plumbing, but not in the outlet fixture. Sample results are then compared to determine the sources of lead contamination and to determine appropriate corrective measures.

The protocol, which consists of an established sample size volume and water retention time, is designed to identify lead problems at outlets and upstream plumbing within school facilities, and in the water entering the facility.

This section provides a brief definition and overview of the purpose of each of the two steps in EPA's lead testing process.

#### 4.4.1 Step 1: Initial Sampling

In Step 1, initial samples are taken from prioritized outlets (e.g., bubblers, fountains) in the facility. These samples determine the lead content of water sitting in water outlets that are used for drinking or cooking within your building(s). A sample is also collected from a tap located as near as possible to the service

connection (i.e., the pipe connecting your facility to a larger water main). Initial service connection samples are flush samples, but the initial samples taken from bubblers, fountains, and other outlets used for consumption are all first-draw samples (i.e., the stagnant water is sampled before any flushing or use occurs). The goal of Step 1 is to compare the lead level of water from your facility's service connection to water that has remained stagnant between 8 and 18 hours in an outlet or fixture.

To determine the lead content in water from your facility's service connection, first contact your public water supplier to identify what lead levels you might expect. *(If you completed the plumbing profile questionnaire in Appendix I that is also discussed in Exhibit 3.1, you will already have this information.)* Second, test water that is representative of your service connection and the mains in your public water system. Compare the results to determine what contribution your service connection is making to lead concentrations in your building (see Exhibit 4.3). Then, compare this finding to the results from outlets in the facility. For sampling instructions for initial samples from service connections, mains, and different types of water outlets, see Exhibits 4.3 through 4.9.

TIP: Some schools may opt to clean the aerators prior to collecting initial first draw samples. However, EPA recommends that the collection of first draw samples without aerators should only be permissible if the outlet does not normally have an aerator, or if your school has a documented routine maintenance program for removing, cleaning, and replacing aerators on drinking water outlets. If your school does not have an aerator maintenance program in place, removing, cleaning, and replacing the aerators prior to sampling for diagnostic purposes will provide sampling results that cannot be assured to represent the water that the children and staff are routinely drinking from the outlet.

Before beginning sampling, you should repair any leaking outlets to ensure that you collect representative samples.

#### 4.4.2 Step 2: Follow-Up Flush Sampling

If initial test results reveal lead concentrations greater than 20 ppb in a 250 mL sample for a given outlet, follow-up flush testing described in Step 2 is recommended to determine if the lead contamination results are from the fixture or from interior plumbing. EPA has established this trigger for follow-up flush testing to ensure that the sources of lead contamination in drinking water outlets are identified. The table below provides details of an additional sub-step that might be taken to eliminate particulate debris that can collect on aerators and screens as a source of lead.

In Step 2, follow-up flush samples are collected and analyzed from outlets whose initial first draw results revealed lead concentrations greater than 20 ppb. The purpose of Step 2 is to pinpoint where (i.e., fixtures or interior plumbing) lead is getting into drinking water so that appropriate corrective measures can be taken.

As with initial first draw samples, follow-up flush samples are to be taken before a facility opens and before any water is used. Follow-up flush samples generally involve the collection of water from an outlet where the water has run for 30 seconds. This sampling approach is designed to analyze the lead content in the water in the plumbing behind the wall. The sampler should induce a small (e.g., pencil-sized) steady flow of water from the outlet or other sample location. The sampler should be careful not to begin with a high rate of flow, and then reduce the flow just prior to sampling. Sudden changes in flow could stir up sediments or cause sloughing of pipe films that would not be characteristic of typical water use patterns.

## Eliminating Particulate Lead as a Source of Lead in Drinking Water

### Alternative Step 2:

If initial first draw sampling results reveal concentrations higher than 20 ppb in the 250 mL sample for a given outlet, a contributing source of the elevated lead levels could be the debris in the aerator or screen of the outlet. By cleaning the aerator or screen and retesting the water following the initial first draw sampling procedures you can identify whether or not the debris is a contributing source to elevated lead levels in your facility.

Determining aerator/screen debris contribution:

**Scenario 1:** Your initial first draw sampling result was higher than 20 ppb, you decide to see if the aerator is a contributing source of lead in the water. After cleaning out your aerator you take another first draw sample.\* The results come back less than or close to 5 ppb or the detection level. This result tells you that the debris in the aerator was contributing to elevated levels in your school. Continue to clean out the aerator on a regular basis and this outlet is O.K. to use. However, please note that without regular maintenance this tap may serve water with elevated lead levels.

**Scenario 2:** Your initial first draw sampling result is 25 ppb, you decide to see if the aerator is a contributing source of lead in the water. After cleaning out your aerator you take another first draw sample.\* The second sample result is very close or equivalent to the 25 ppb sample. Since your initial first draw sample and alternative second first draw sample results are similar, the problem is upstream from the aerator. Continue to follow the sampling protocol and do your follow-up flush sampling.

**Scenario 3:** Your initial first draw sampling result is 60 ppb, you decide to see if the aerator is a contributing source of lead in the water. After cleaning out your aerator you take another first draw sample.\* The second sample result is 25 ppb. While your results are lower, but still above 20 ppb, this tells you that the aerator or screen is a contributing source and that the plumbing upstream of the aerator is contributing as well. If this situation occurs, you should continue with follow-up flush sampling to target the additional contributing sources.

*\* When taking your second first draw sample, please remember to follow the same sampling procedure as your initial first draw sample.*

A comparison of initial and follow-up samples will help to assess where the lead may be getting into the drinking water. See Exhibits 4.3 through 4.8 for follow-up flush sampling instructions for various types of outlets.

After follow-up flush sampling, additional samples from the interior plumbing within the building are also often necessary to further pinpoint the sources of lead contamination. See Exhibit 4.9 for instructions for additional sampling.

After reviewing the plumbing profile questionnaire and background regarding what your answers to the profile could mean (Exhibit 3.1), you have learned that lead contamination may not occur uniformly throughout a building. You should have an idea of the type of water you are receiving. From this assessment, you will then have a better sense of how to organize your testing activities. When planning your strategy, it is important to note that large variations in lead concentrations may be found among individual outlets in a facility because of differences in flow rates and/or building materials.

In general, you may find widespread presence of lead in your drinking water when:

- Lead pipes are used throughout the facility.
- The building's plumbing is less than 5 years old and lead solder was illegally used (i.e., after the "lead-free" requirements of the 1986 Safe Drinking Water Act Amendments took effect). This situation is rare.
- The water is corrosive.
- Sediment or scale in the plumbing and faucet screens contain lead.
- Brass fittings, faucets, and valves were installed throughout the building less than five years ago (even though they may contain less than the "lead-free" requirements of the Safe Drinking Water Act).
- The service connection (i.e., the pipe that carries water from the public water system main to the building) is made of lead.

In general, you may find localized presence of lead if:

- Some brass fittings, faucets, and valves have been installed in the last five years (even though they may meet the SDWA "lead-free" requirement).
- Drinking water outlets are in line with brass flush valves, such as drinking water fountains near restroom supply piping.
- Lead pipes are used in some locations.
- The water is non-corrosive.
- Lead solder joints were installed in short sections of pipe before 1986 or were illegally installed after 1988 (i.e., after the lead-free requirements of the Safe Drinking Water Act took effect).
- There are areas in the building's plumbing with low flow or infrequent use.
- Sediment in the plumbing and screens frequently contains lead.
- Some water coolers or other outlets have components that are not lead-free, especially if the water is corrosive.

After identifying potential problem areas in your facility through completion of a plumbing profile, the next step is to have the water tested. A sampling plan should be developed before testing begins. Key issues to consider in devising a sampling plan include the following:

- Who will be in charge of the sampling effort?
- Who will collect and analyze samples and maintain records?
- Where will the samples be taken?

### 4.4.3 Initial and Follow-Up Sampling Protocol

The protocol for collecting initial first draw and follow-up flush samples varies by type of drinking water outlet. The initial first draw and follow-up flush testing protocols and the interpretation of test results are described in Exhibits 4.3 through 4.9 for the following locations and type of outlets:

- **Service connections and water mains**
- **Drinking water fountains** (*four types*)
  - Bubblers or drinking water fountains (without central chillers): water is supplied to the bubbler or fountain directly from the building's plumbing.
  - Bubblers or drinking water fountains (with central chillers): a central chiller unit cools water for a number of drinking water fountains or bubblers in the building.
  - Water coolers: devices are equipped with their own cooling and storage systems; water is supplied to the device from the building's plumbing.
  - Bottled water dispensers: type of water fountain whose water is supplied from bottled water.

*Note: The Food and Drug Administration (FDA) regulates bottled water. EPA recommends testing the dispenser to ensure that the dispenser is not contributing lead to the water.*

- **Ice making machines**
- **Water faucets**
- **Interior plumbing**

Please note that sampling ID codes have been indicated in the descriptions of the sampling protocol for each outlet type. These sampling ID codes have been included for illustrative purposes only. When you conduct testing in your facility, you should assign your unique numbers for every sample you collect.

Following the instructions for the above water outlet locations are instructions for conducting sampling of the interior plumbing of buildings (Exhibit 4.9). Instructions are included for sampling laterals, loops and headers, and riser pipes. These types of samples are necessary if outlet follow-up flush samples show lead levels above 20 ppb.

**TIP:** Schools may wish to collect both initial and follow-up samples at the same time. This is more convenient and may save time and money if a contractor has been hired to collect the samples. However, using this approach creates a trade-off between convenience and confidence. The confidence in the sample results will decrease since flushing water through an outlet after taking the initial sample could compromise the flushed samples taken at subsequent outlets, depending upon the plumbing configuration. As succeeding outlets are flushed, the chances of compromising the remaining flushed samples would increase.

Exhibit 4.2 provides an overview of the sampling process in a flow chart format.

As discussed in section 4.1, you may wish to modify sampling recommendations to suit your site conditions. For example, if you believe that flushing an outlet for 30 seconds prior to taking a follow-up flush sample is excessive, you may wish to calculate a more accurate time estimate. This could be done by:

- Calculating the pipe volume in gallons between the outlet and the location in the plumbing that you want to sample.
- Measuring the outlet flow in gallons per minute.
- The length of time for flushing can be determined by dividing the pipe volume in gallons by the outlet flow in gallons per minute.

Pipe volumes per foot of pipe length for various pipe sizes are shown in Exhibit 4.1 below.

### Exhibit 4.1: Pipe Volumes for Copper Pipe

Nominal Pipe Diameter (inches)	Approximate Capacity (gallons per foot of length)	
	Type K Copper (soft)	Type L Copper (rigid)
3/8	0.0066	0.0075
1/2	0.0113	0.0121
3/4	0.0226	0.0251
1	0.0404	0.0429
1 1/4	0.0632	0.0653
1 1/2	0.0895	0.0924
2	0.1566	0.1607
2 1/2	0.2412	0.2479
3	0.3448	0.3538



**Exhibit 4.2: Sample Strategy Flowchart**

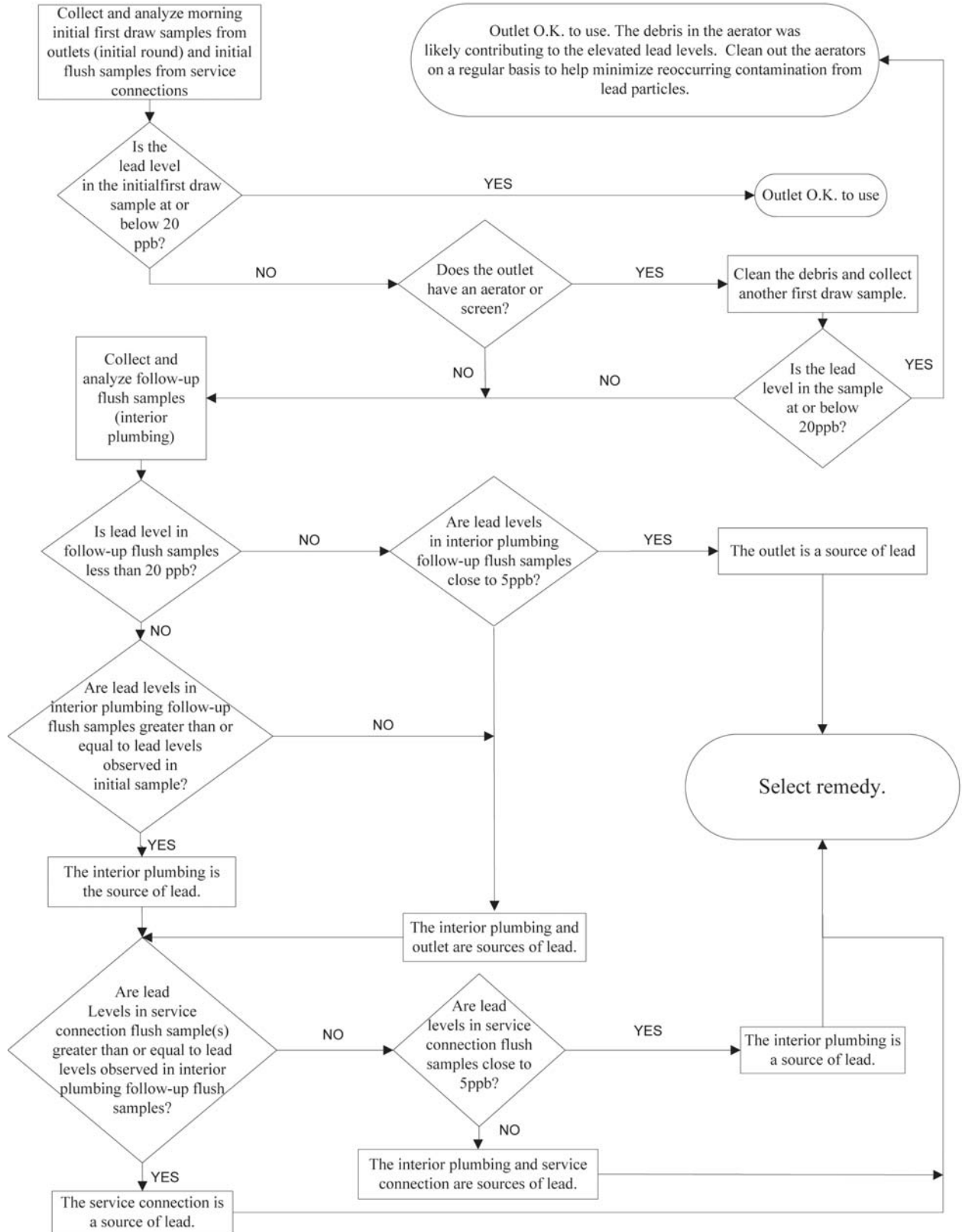

#### 4.4.4 Sampling for Other Parameters

In addition to monitoring for lead, you may wish to monitor for other parameters that may provide an indication of problems in your plumbing. However, note that analysis costs will increase as the number of parameters increases. Some other parameters are listed in the following table:

Contaminant	Limit	Concern
Cadmium	5 ppb	A regulated toxic metal found in low levels in galvanized pipe. The maximum allowable level is 5 ppb. However, the presence of cadmium at any level indicates that corrosive conditions may exist in the plumbing.
Color	15 color units	An aesthetic parameter that may indicate the presence of iron oxides. Iron oxides are often present in iron or steel pipe as a result of corrosive conditions.
Copper	1300 ppb	A regulated toxic metal used to make copper piping. The presence of copper in water samples taken from copper piping is not unusual, but higher levels indicate that corrosive conditions may be a concern.
Iron	300 ppb	An aesthetic parameter that is indicative of corrosive conditions at higher levels. See also color and turbidity. (Galvanized pipe is typically made of iron.)
Turbidity	1 turbidity unit	A measurement of the clarity of water. Higher turbidity values may indicate the presence of iron oxides. Iron oxides are often present in iron or steel pipe as a result of corrosive conditions.
Zinc	5000 ppb	An aesthetic parameter that is indicative of corrosive conditions at higher levels. Zinc is used in making galvanized piping products. The presence of zinc in water samples taken from galvanized piping is not unusual, but higher levels indicate that corrosive conditions may be a concern.

### Exhibit 4.3: Service Connection Sampling

Lead pipes are still used for service connections in some locations. Other materials used for service connections include copper, galvanized steel, plastic, and iron. Lead service connections can produce significant lead levels in your drinking water.

To test water in your service connection, locate the tap closest to the service connection. This is especially important for larger facilities where more than one service connection is present.

#### Sample Collection Procedures:

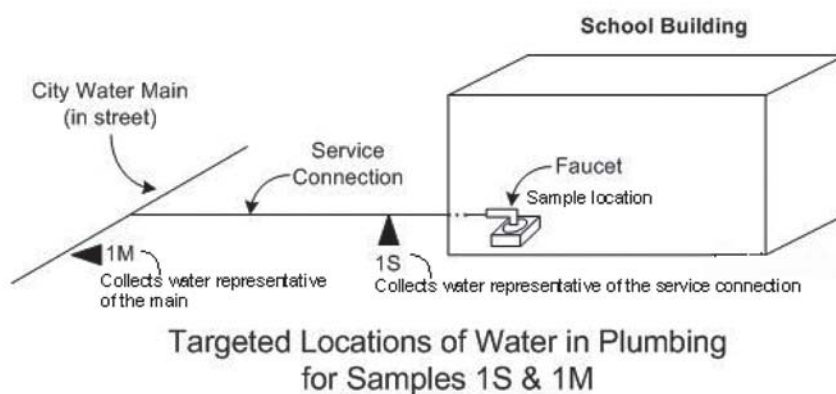

#### Sample 1S (Service Connection)

Take this sample before the facility opens. Note that this initial sample is not a first-draw sample. Open the cold water tap closest to the service connection. Let the water run, and feel the temperature of the water. Depending upon the temperature of your public water system's water and the temperature of the room, you may feel the water temperature change as the water from the service connection enters the building. However, it is possible that the water in the service connection and the building are close to the same temperature. Therefore, you should collect the sample immediately after a temperature change is detected, or after 30 seconds. Flushing removes the water that was in the facility's interior plumbing and allows sampling of the water that was in the service connection. You may wish to calculate a more accurate flush time for your building by using the method described in section 4.4.3.

#### Sample 1M (Water Main)

This sample is representative of the water that is provided by the distribution main. Take the sample from the same location as sample 1S. Let the water run, and feel the temperature of the water. If you can feel a change in water temperature, allow the water to run an additional 3 minutes after the temperature changes and then collect the sample. If you cannot feel a change in temperature, allow the water to run for 3 minutes and 30 seconds.

If possible, you should take this sample from a faucet rather than a drinking fountain because of the limited flow that is normally provided by a drinking fountain. Also, a change in temperature may be difficult to detect if the sample is taken from a water cooler (see the discussions for Samples 1S and 1M below).

### **Interpreting Test Results:**

- If the lead level of Sample 1S (service connection) significantly exceeds 5 ppb (for example, 10 ppb) and is higher than in sample 1M, lead is contributed from the service connection. Check for the presence of a lead service connection by scratching it with a knife or key. (Lead test kits are available from water testing and laboratory supply companies and are relatively inexpensive.) Lead is soft and dull gray in appearance. When scratched, it will be shiny. In the absence of a lead service connection, lead goosenecks or other materials containing lead may be the source of the contamination.
- If the lead level of Sample 1M (water main) significantly exceeds 5 ppb (for example, 10 ppb), lead in the water may be attributed to the source water, sediments in the main, or to lead in the distribution system such as from lead joints used in the installation or repair of cast iron pipes.
- If the lead levels of Samples 1S and 1M are very low (close to 5 ppb), very little lead is being picked up from the service line or the distribution main. Usually, no significant amount of lead (above 5 ppb) comes from the public water system.

For example scenarios of different water sample results, please see Appendix H.

## Exhibit 4.4: Drinking Water Fountains: Bubblers

Do not close the shut-off valves to the water fountains to prevent their use prior to sample collection. Minute amounts of scrapings from the valves will produce inaccurate results showing higher than actual lead levels in the water. Take all samples with the taps fully open.

### Sample Collection Procedures:

- **Initial First Draw Screening Sample 1A**

This sample is representative of the water that may be consumed at the beginning of the day or after infrequent use. It consists of water that has been in contact with the bubbler valve and fittings and the section of plumbing closest to the outlet of the unit.

Take this sample before the facility opens and before any water is used. Collect the water immediately after opening the valve without allowing any water to run into the drain. Take follow-up samples from those bubblers where test results indicate lead levels over 20 ppb.

- **Follow-Up Flush Sample 2A**

This sample is representative of the water that is in the plumbing upstream from the bubbler (from the bubbler back toward the service connection and the water main). Take this sample before the facility opens and before any water is used. Let the water from the fountain run for 30 seconds before collecting the sample. If several bubblers are served by a central chiller, samples should be taken from different bubblers on different days.



One Style of Drinking Water Fountain

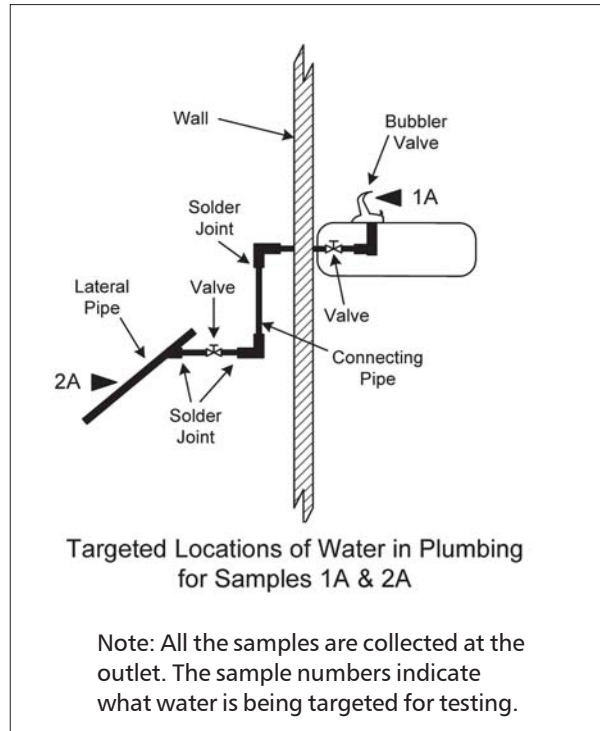

## Interpreting Test Results:

To determine the source of lead in the water, compare the test results of Samples 1A and 2A.

- If the lead level in Sample 1A is higher than that in Sample 2A, a portion of lead in the drinking water is contributed from the bubbler.
- If the lead level in Sample 2A is very low (close to 5 ppb), very little lead is picked up from the plumbing upstream from the outlet. The majority or all of the lead in the water is contributed from the bubbler.
- If the lead level in Sample 2A significantly exceeds 5 ppb (for example, 10 ppb), lead in the drinking water is also contributed from the plumbing upstream from the bubbler.
- If the lead level in Sample 2A exceeds 20 ppb, EPA recommends collecting follow-up flush samples from the header or loop supplying water to the lateral to locate the source of the contamination. (*Sampling instructions for interior plumbing can be found in Exhibit 4.9.*)



Fountains Connected to a Central Chiller

For example scenarios of water sample results and possible solutions, see Appendix H.



## Exhibit 4.5: Drinking Water Fountains: Water Coolers

Do not close the valves to the water fountains to prevent their use prior to sample collection. Minute amounts of scrapings from the valves will produce inaccurate results showing higher than actual lead levels in the water. Take all samples with the taps fully open.

### Sample Collection Procedures:

Two types of water coolers are used: the wall-mounted and the free-standing types. Water in these coolers is stored in a pipe coil or in a reservoir. Refrigerant coils in contact with either of these storage units cools the water. Sources of lead in the water may be the internal components of the cooler, including a lead-lined storage unit; the section of the pipe connecting the cooler to the lateral pipe; and/or the interior plumbing of the building.

Prior to testing, check the make and model numbers of your water coolers and compare them to EPA's listing of coolers that have lead parts or lead-lined tanks (*see Appendix E for a summary of the water cooler issues and EPA's list of affected coolers*). If you have a Halsey Taylor cooler that is on EPA's list of coolers with lead-lined tanks, consult Halsey Taylor for information on their replacement/refund program and associated testing directions. Contact information is provided in Appendix E.



Wall-Mounted Cooler

Regardless of whether your water cooler appears on EPA's listing, initial testing should be conducted.

- **Initial First Draw Screening Sample 1C**

This sample is representative of the water that may be consumed at the beginning of the day or after infrequent use. (In areas of infrequent use, the water may not have been used in more than 18 hours. This is acceptable if this is representative of the normal water consumption pattern.) The sample consists of water that has been in contact with the interior plumbing, the valve and fittings, the storage unit, and the section of plumbing closest to the outlet of the unit.

Take this sample before the facility opens and before any water is used. Collect the water immediately after opening the faucet without allowing water to waste. Take follow-up flush samples from water coolers whose test results indicate lead levels greater than 20 ppb.

When conducting follow-up flush testing with water coolers you should be aware that some

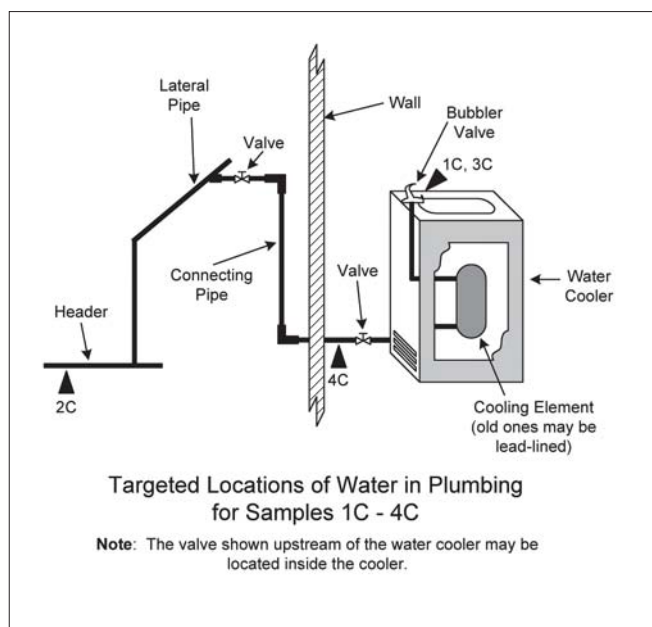



water coolers manufactured before 1988 may have storage tanks lined with materials containing lead. You should contact the manufacturer of any water cooler units you have purchased or are planning to purchase for written guarantees that the unit is lead-free. *A list of makes and model numbers of coolers that contain lead has been prepared by EPA and is summarized in Appendix E.*

- **Follow-Up Flush Sample 2C**

This water sample is representative of the water that is in contact with the header or rising piping upstream of the cooler. Take this sample after the facility closes. Let the water from the fountain run for 15 minutes before collecting the sample. You must flush the cooler for 15 minutes to ensure that no stagnant water is left in the storage unit.

- **Follow-Up First Draw Sample 3C**

Take this sample before the facility opens and before any water is used. This sample must be taken the morning after you collect Follow-Up Flush Sample 2C. Collect the water immediately after opening the faucet without allowing any water to waste.

Because the water in the cooler was flushed the previous afternoon, this sample is representative of the water that was in contact with the cooler overnight, not in extended contact with the plumbing upstream. As such, it may differ from Initial First Draw Screening Sample 1C.

## Interpreting Test Results:

- IF Follow-up  
Sample 3C IS GREATER THAN Follow-up  
Sample 2C THEN

→ *The water cooler may be contributing lead.*
  
- IF Follow-up  
Sample 3C IS GREATER THAN Follow-up  
Sample 2C AND

Initial  
Sample 1C IS GREATER THAN Follow-up  
Sample 3C THEN

→ *The upstream plumbing may also be contributing lead.*
  
- IF Follow-up  
Sample 2C IS CLOSE OR EQUAL TO Follow-up  
Sample 3C THEN

→ *The water cooler is probably not contributing lead.*
  
- IF Follow-up  
Sample 1C IS GREATER THAN Follow-up  
Sample 3C AND

Follow-up  
Sample 2C IS CLOSE OR EQUAL TO Follow-up  
Sample 3C THEN

→ *The water cooler and/or upstream plumbing are probably contributing lead.*
  
- IF Follow-up Sample  
2C > 20 ppb, AND IS GREATER THAN OR EQUAL TO Initial Sample 1C &  
Follow-up Sample  
3C THEN

→ *The source of the lead may be sediments contained in the cooler storage tank, screens, or the plumbing upstream from the cooler.*

- **Follow-Up First Draw Sample 4C**

To confirm whether the cooler is the source of lead, take Follow-Up First Draw Sample 4C.

Turn off the valve leading to the cooler. Disconnect the cooler from the plumbing and look for a screen at the inlet. Remove the screen. If there is debris present, check for the presence of lead solder by sending a sample of the debris to the laboratory for analysis.

Some coolers also have a screen installed at their outlet. Carefully remove the bubbler outlet by unscrewing it. Check for a screen and debris and have a sample of any debris analyzed.

Some coolers are equipped with a drain valve at the bottom of the water reservoir. Water from the bottom of the water reservoir should be sampled and any debris analyzed.

Collect Sample 4C from the disconnected plumbing outlet in the same manner as you collected Sample 1C. Compare the results from Sample 4C to the other sample results.

**Interpreting Additional Water Cooler Test Results:**

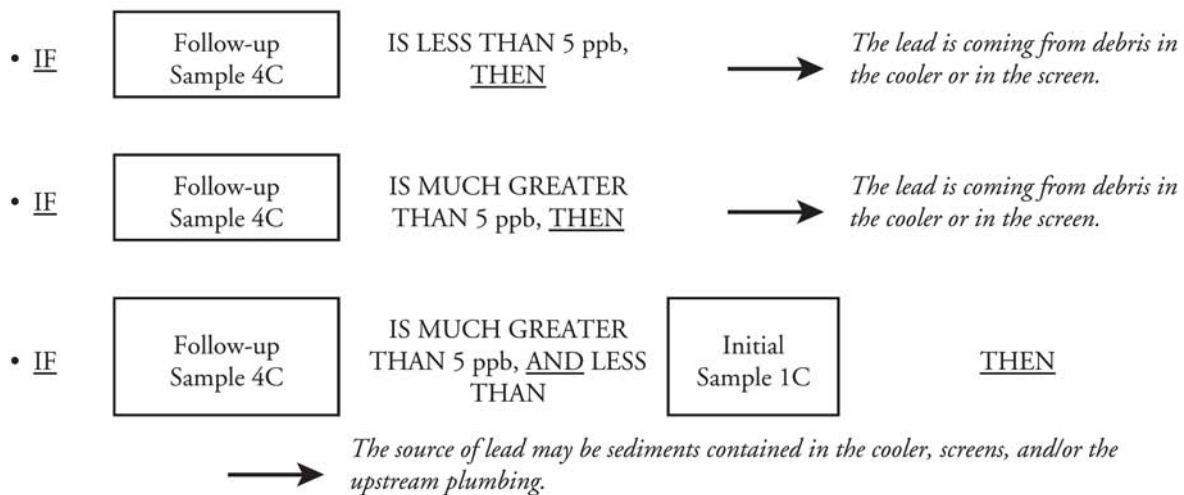

For example scenarios of water sample results and possible solutions, see Appendix H.

## Exhibit 4.6: Drinking Water Fountains: Bottled Water Dispensers

### Sample Collection Procedures:

This testing will identify if lead is being contributed to the water from the dispenser.

*Notes: The Food and Drug Administration (FDA), regulates the interstate sale of bottled water and has established a 5 ppb standard for lead in bottled water. EPA recommends that you contact your distributor for written assurance that the bottled water does not exceed federal or state bottled water standards, and a copy of recent test results.*

- **Initial First Draw Screening Sample 1D**

This sample is representative of the water that may be consumed at the beginning of the day or after infrequent use. It consists of water that has been in contact with the dispenser valve and fittings incorporated in the outlet of the unit.

Take this sample before the facility opens and before any water is used. Collect the water immediately after opening the faucet without allowing any water to waste. Take follow-up flush samples from those bottled water dispensers where test results indicate lead levels over 20 ppb.

- **Follow-Up Flush Sample 2D**

Collect this sample directly from the bottle that supplies the water to the unit. This will enable you to determine the source of lead in the water. See the Note below for an alternative to follow-up sampling.



Bottled Water  
Dispenser

### Interpreting Test Results:

- If the sample contains lead, contact the water supplier and/or the manufacturer of the dispenser to ask for their recommendations.
- If the lead level in Sample 1D is higher than that in Sample 2D, lead may be coming from the dispenser unit.
- If the lead level in Sample 2D is identical or close to that in Sample 1D, the source of lead is the bottled water.

*Note: Many dispensers have a hot and cold tap. Water from both taps is meant to be directly consumed, therefore, both taps should be sampled. However, you may wish to sample the hot water tap on a separate day.*

For example scenarios of water sample results and possible solutions, see Appendix H.

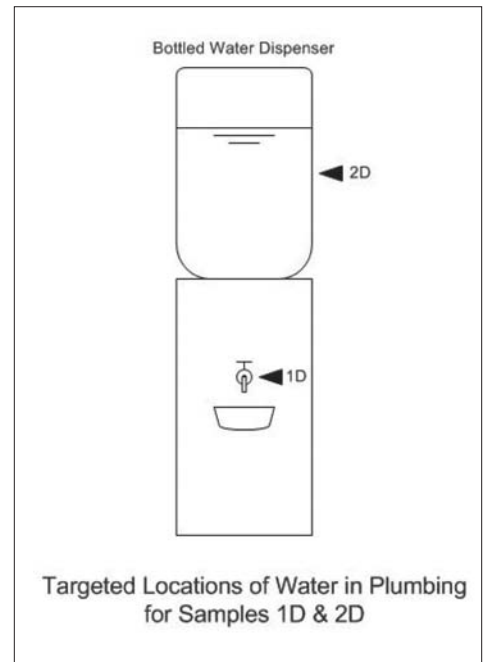

## Exhibit 4.7: Ice Making Machines

### Sample Collection Procedures:

- Initial Screening Sample 1E**  
 Fill a suitable container (250 mL or larger, wide-mouthed bottle or other container) provided by the laboratory at least three-quarters full of ice. Do not touch the ice with your hands. Use the non-metal scoop or disposable plastic gloves provided by the laboratory to place the ice in the container.  
  
 If the lead level in Sample 1E exceeds 20 ppb, collect a follow-up sample to determine if the source of the lead is the plumbing or the ice making machine itself.

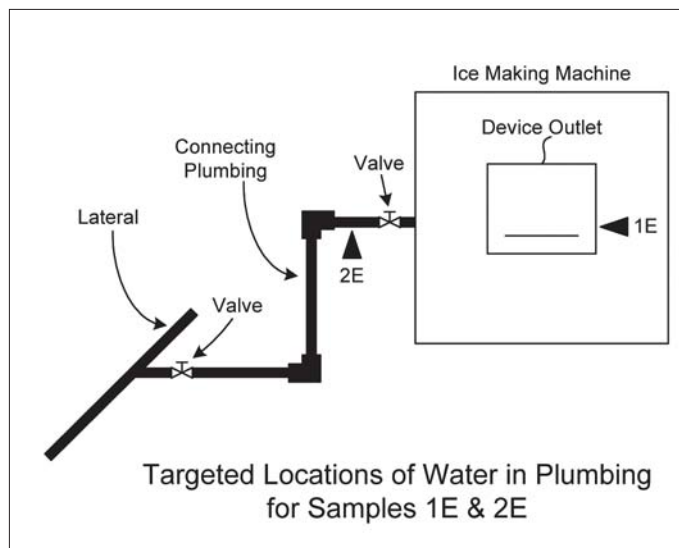

- Follow-Up Sample 2E**  
 Disconnect the ice maker from the plumbing and look for a screen at the inlet. Remove the screen. If debris is present, forward a sample of the debris to the laboratory for analysis and clean out the remaining debris. The laboratory will determine whether lead solder is present. Clean the screen routinely to avoid accumulations of debris.  
  
 Collect the sample from the disconnected plumbing as close to the ice maker as possible. Fill the sample container with 250 mL of water. If no tap is available, contact the ice machine manufacturer for recommendations that will minimize disruption of existing plumbing. Adding taps or valves could add new sources of lead to the plumbing, even if the new devices are lead-free and meet NSF Standard 61, section 8. If a sample tap or valve is available, collect the sample immediately after opening the tap or valve.

### Interpreting Test Results:

- If the lead level in Sample 2E is close to 5 ppb, the source of the lead in the ice is the ice maker.
- If the lead level in Sample 2E significantly exceeds 5 ppb (for example, 10 ppb), lead is also contributed from the plumbing upstream from the ice maker.
- If the lead level in Sample 2E exceeds 20 ppb, EPA recommends collecting follow-up flush samples from the distribution system supplying water to the ice maker. *Refer to Exhibit 4.9 on Sampling Interior Plumbing for instructions.*

For example scenarios of water sample results, please see Appendix H.

## Exhibit 4.8: Water Faucets (Taps)

### Sample Collection Procedures:

- **Initial First Draw Screening Sample 1F**

This sample is representative of the water that may be consumed at the beginning of the day or after infrequent use. It consists of water that has been in contact with the fixture and the plumbing connecting the faucet to the lateral pipes.

Take this sample before the facility opens and before any water is used. If your facility has a routine maintenance program for removing, cleaning, and replacing aerators you can perform this task prior to collecting the sample.

Using the cold water tap, collect the water immediately after opening the faucet without allowing any water to go to waste. Follow-up flush samples should be taken from those water faucets where initial screening test results indicate lead levels over 20 ppb.

- **Follow-Up Flush Sample 2F**

This sample is representative of the water that is in the plumbing upstream from the faucet. Take this sample before school opens and before any water is used. Let the water from the faucet run for 30 seconds before collecting the sample.

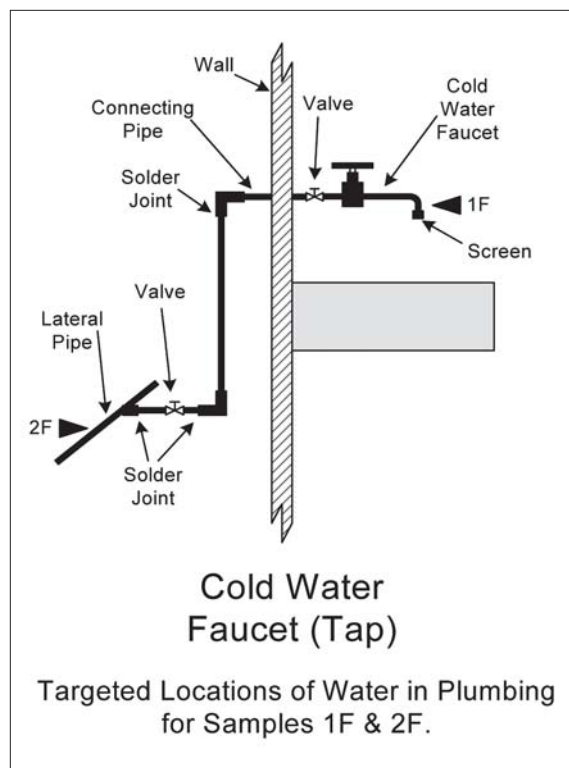

### Interpreting Test Results:

- If the lead level in Sample 1F is higher than that in Sample 2F, the source of lead is the water faucet and/or the plumbing upstream from the faucet.
- If the lead level in Sample 2F is very low, close to 5 ppb, very little lead is coming from the plumbing upstream from the faucet. The majority or all of the lead in the water is from the faucet and/or the plumbing connecting the faucet to the lateral.
- If the lead level in Sample 2F significantly exceeds 5 ppb (for example, 10 ppb), lead may be contributed from the plumbing upstream from the faucet.

For example scenarios of water sample results and possible solutions, see Appendix H.

## Exhibit 4.9: Sampling Interior Plumbing

---

In general, if lead levels exceed 20 ppb in follow-up samples taken from drinking water outlets, additional samples from upstream sample sites in the interior plumbing should be collected. EPA recommends that water samples from each lateral, header and riser (where applicable) be collected because use patterns may vary among locations within a building. The configuration of interior plumbing will vary depending on the layout of a given building. Construction materials may also vary, especially in larger buildings where additions and repairs have been made to the original structure. *See Exhibits 4.10 and 4.11 for simplified diagrams of the interior plumbing in single-level and multi-level buildings.*

Sampling should proceed systematically upstream from follow-up sample sites that exceed 20 ppb. (*However, you do not have to sample at upstream sites where follow-up samples have already been taken.*) The goal of this sampling effort is to isolate those sections of the interior plumbing that contribute lead to the water. This is achieved by comparing the results of interior plumbing samples with each other, and with the results of previously collected follow-up samples.

Developing procedures from upstream sampling from laterals, headers and risers can be difficult because of the wide variation in plumbing configurations among facilities. As discussed in 4.4.3, the sampling procedures in this manual were developed for typical configurations that may not be similar to your facility. You may wish to either develop your own sampling procedures using the guidance provided in 4.4.3, or retain a consultant for guidance in this process.

### Laterals

A lateral is a plumbing branch between a fixture or group of fixtures (e.g., taps, water fountains, etc.) and a header.

### Sample Collection Procedures:

- **Sample 1G (lateral)**  
Open the outlet that has been designated as the sample site for the lateral pipe. Let the water run for 30 seconds before collecting the sample. Collect a 250 mL sample. The purpose of flushing the water is to clear the plumbing between the sample site and the lateral pipe. This action will ensure collection of a representative sample.

*Note: Sample 1G corresponds to follow-up samples taken from other outlets such as 2A, 2E and 2F. Compare the results of these samples from outlets upstream and downstream of Sample 1G for additional information on the source of the lead within the interior plumbing. (As noted above, you do not have to take sample 1G at sites where follow-up samples have already been taken. The previous results are adequate.)*



## Interpreting Test Results:

- IF Follow-up Sample 1G IS GREATER THAN 20 ppb THEN

→

*Collect additional samples from the plumbing upstream where samples have not been previously taken; i.e., from the header that feeds the lateral, the riser pipe (if applicable), or the service connection.*

*Note: High lead levels may be caused by recent repairs or by sediment in the plumbing. Sediment should be sent to a laboratory for analysis.*
  
- IF Follow-up Sample 1G IS CLOSE OR EQUAL TO Initial results from a downstream outlet THEN

→

*The lead is contributed from the lateral and/or from interior plumbing upstream from the lateral. Possible sources include the lateral, header, riser pipe, or service connection.*
  
- IF Follow-up Sample 1G IS CLOSE OR EQUAL TO 5 ppb THEN

→

*The portion of the lateral upstream from Sample Site 1G and the interior plumbing supplying water to the lateral are probably not contributing lead. The source is downstream from Sample Site 1G.*
  
- IF Follow-up Sample 1G IS APPROXIMATELY 10 ppb OR GREATER AND IS LESS THAN Initial results from a downstream outlet THEN

→

*A portion of the lead is contributed from the plumbing downstream from Sample Site 1G.*

## Headers

A header is the main water supply pipe on a given floor of a building. A header supplies water to laterals. In smaller buildings, a header may be very short and/or have a relatively small diameter.

## Sample Collection Procedures:

- **Sample 1H (header)**

Locate the sampling point furthest from the service connection or riser pipe (see discussion of riser pipes on the next page) on the floor. You should try to take this sample from a faucet to provide adequate flushing through the tap. Open the faucet and let it run for 30 seconds before collecting this sample. Fill the sample container with 250 mL of water. The purpose of flushing the water is to clear the faucet and plumbing between the sample site and the header pipe.

## Interpreting Test Results:

- IF Follow-up Sample 1H IS GREATER THAN 20 ppb THEN  
 → *Collect additional samples from the plumbing upstream that supplies water to the header (if not already done); i.e., the riser pipe (if applicable), or the service connection.*

*Note: High lead levels may be caused by recent repairs or by sediment in the plumbing. Sediment should be sent to a laboratory for analysis.*

- IF Follow-up Sample 1H IS CLOSE OR EQUAL TO Initial results from a downstream outlet THEN  
 → *The lead is contributed from the header and/or from interior plumbing upstream from the header. Possible sources include the header, riser pipe, or service connection.*

- IF Follow-up Sample 1H IS CLOSE OR EQUAL TO 5 ppb THEN  
 → *The portion of the header upstream from Sample Site 1H and the interior plumbing supplying water to the header are probably not contributing lead. The source is downstream from Sample Site 1H.*

- IF Follow-up Sample 1H IS APPROXIMATELY 10 ppb OR GREATER AND IS LESS THAN Initial results from a downstream outlet THEN  
 → *A portion of the lead is contributed from the plumbing downstream from Sample Site 1H.*

## Riser Pipes

A riser is the vertical pipe that carries water from one floor to another.

### Sample Collection Procedures:

- **Sample 1J**  
Open the tap closest to the riser pipe. Let the water run for 30 seconds before collecting the sample. Fill the sample container with 250 mL of water. The purpose of flushing is to clear the faucet and plumbing between the sample site and the riser pipe.

### Interpreting Test Results:

- IF

Follow-up Sample 1J
------------------------

 IS GREATER THAN 20 ppb, THEN  
  
→ *Collect additional samples from the plumbing upstream that supplies water to the riser (if not already done); i.e., a riser from another floor, or the service connection.*  
  
*Note: High lead levels may be caused by recent repairs.*
- IF

Follow-up Sample 1J
------------------------

 IS CLOSE OR EQUAL TO 

Initial results from a downstream outlet
---

THEN  
  
→ *The lead is contributed from the riser and/or from interior plumbing upstream from the sample site. Possible sources include the riser pipes on other floors or the service connection.*
- IF

Follow-up Sample 1J
------------------------

 IS CLOSE OR EQUAL TO 5 ppb, THEN  
  
→ *The portion of the riser upstream from Sample Site 1J and the service connection are probably not contributing lead. The source is downstream from Sample Site 1J.*
- IF

Follow-up Sample 1J
------------------------

 IS APPROXIMATELY 10 ppb OR GREATER AND IS LESS THAN 

Initial results from a downstream outlet
---

THEN  
  
→ *A portion of the lead is contributed from the plumbing downstream from Sample Site 1J.*

For example scenarios of water sample results and possible solutions, see Appendix H.

### Sample Collection Procedures – Central Chiller Unit:

- **Follow-Up First Draw Sample 1K**

This sample is representative of water that has been in contact with the plumbing supplying water to the chiller. Take this sample before the facility opens and before any water is used. Take the sample from a tap or valve as close to the inlet of the chiller as possible. If no tap is available, contact the chiller manufacturer for recommendations that will minimize disruption of existing plumbing. Adding taps or valves could add new sources of lead to the plumbing, even if the new devices are lead-free and meet NSF Standard 61. If a sample tap or valve is available, collect the sample immediately after opening the tap or valve, without allowing any water to waste.

- **Follow-Up First Draw Sample 2K**

This water sample consists of water that has been in contact with the chiller unit and the plumbing upstream which supplies water to the chiller. Often, water supplied to the bubblers is recirculated to the chiller unit. In this instance, Sample 2K consists of a mixture of water from the water supply and any water that may be recirculated from the plumbing supplying water to the bubblers.

Take the sample from a tap or valve as close to the outlet of the chiller as possible. If no tap is available, contact the chiller manufacturer for recommendations that will minimize disruption of existing plumbing. Adding taps or valves could add new sources of lead to the plumbing, even if the new devices are lead-free and meet NSF Standard 61. If a sample tap or valve is available, collect the sample immediately after opening the tap or valve.

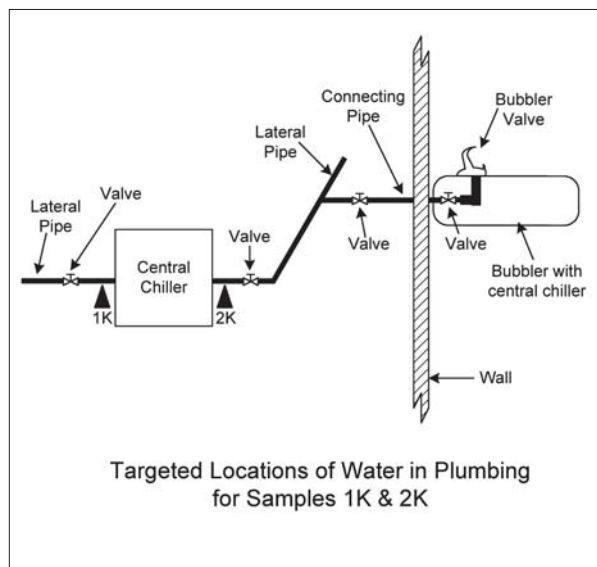

### Interpreting Test Results – Central Chiller Unit:

*Note: You will need the results from samples collected at the bubblers per instructions in exhibit 4.4.*

- If the lead level in Sample 2A is higher than that in Sample 2K, lead is contributed from the plumbing supplying the water from the chiller to the bubbler.
- If the lead level in Sample 2K is higher than in Sample 1K, a portion of the lead may be coming from the chiller. Note: Sludge and sediments containing high levels of lead may accumulate in chiller tanks. If the test results indicate that lead is contributed from the chiller unit, check for the presence of debris and sludge. Remove any of these materials from the chiller, flush the chiller unit, and resample the water.
- If the lead level in Sample 1K exceeds 20 ppb, EPA recommends additional sampling from the distribution system supplying water to the chiller to locate the source of contamination.
- If the lead level in Sample 1K is very low (close to 5 ppb), very little lead is picked up from the plumbing upstream from the chiller. The majority or all of the lead in the water may be attributed to the chiller and the plumbing downstream from the chiller.

For example scenarios of water sample results and possible solutions, see Appendix H.

### Exhibit 4.10: Sample Sites for a Single-Level Building

- ① Morning first-draw samples from coolers, faucets, bubblers, etc. (Initial Screening Samples 1A, 1C, 1D, 1E, 1F.)
- ② Samples from lateral after 30-second flush from designated outlets. (Follow-up Samples 2A, 2E, 2F, 1G.)
- ③ Samples from coolers after 15-minute flush. (Follow-up Sample 2C.)
- ④ Samples from coolers morning first-draw. (Follow-up Sample 3C.)
- ⑤ Morning first-draw from coolers at disconnected plumbing outlet. (Follow-up Sample 4C.)
- ⑥ Sample from header pipe taken from faucet farthest from service line. (Sample 1H.)
- ⑦ Sample from service line and distribution main taken from faucet closest to service line. (Samples 1M, 1S.)

**Note:** Simplified header and lateral configurations are shown for clarity.

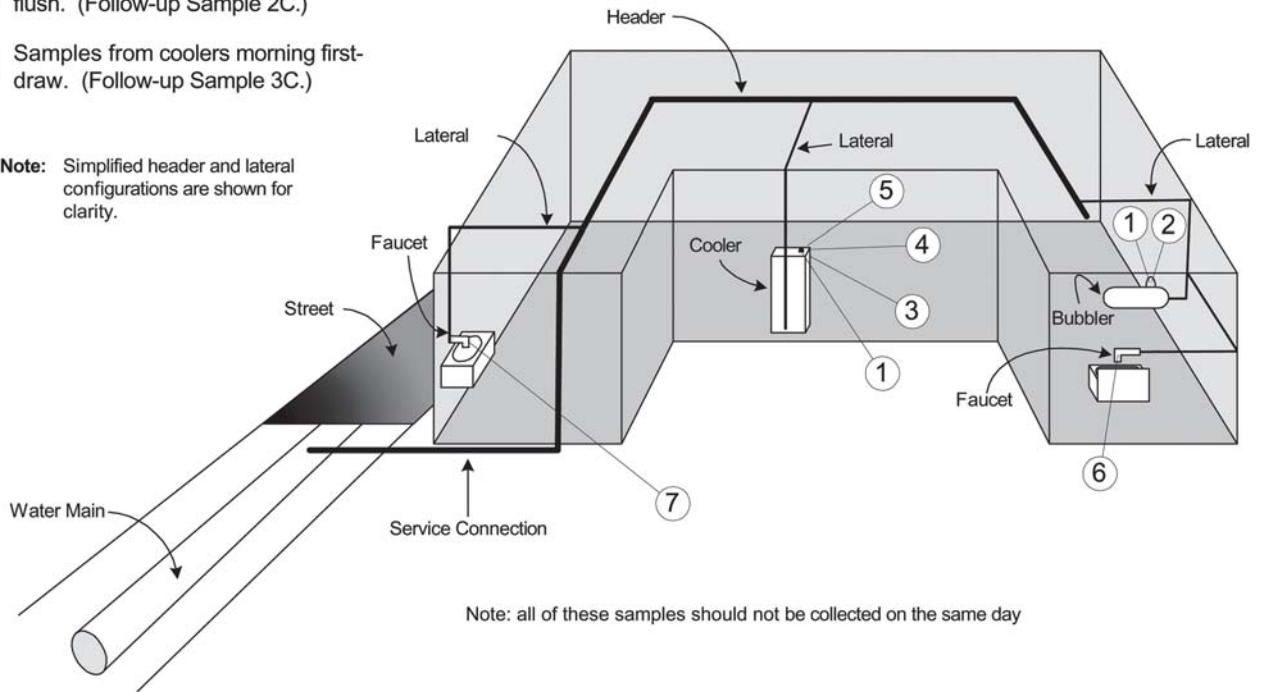

### Exhibit 4.11: Sample Sites for a Multi-Level Building

- ① Morning first-draw samples from coolers, faucets, bubblers, etc. (Initial Screening Samples 1A, 1C, 1D, 1E, 1F.)
- ② Samples from laterals after 30-second flush from designated outlets. (Follow-up Samples 2A, 2E, 2F, 1G.)
- ③ Sample from header taken from faucet farthest from riser pipe. (Sample 1H.)
- ④ Sample from riser pipe taken from faucet closest to riser pipe. (Sample 1J.)
- ⑤ Samples from service line and distribution main taken from tap closest to service connection. (Sample 1H.)
- ⑥ Sample from inlet to chiller unit. (Follow-up sample 1K.)
- ⑦ Sample from outlet of chiller unit. (Follow-up sample 2K.)

**Note:** Simplified header and lateral configurations are shown for clarity.

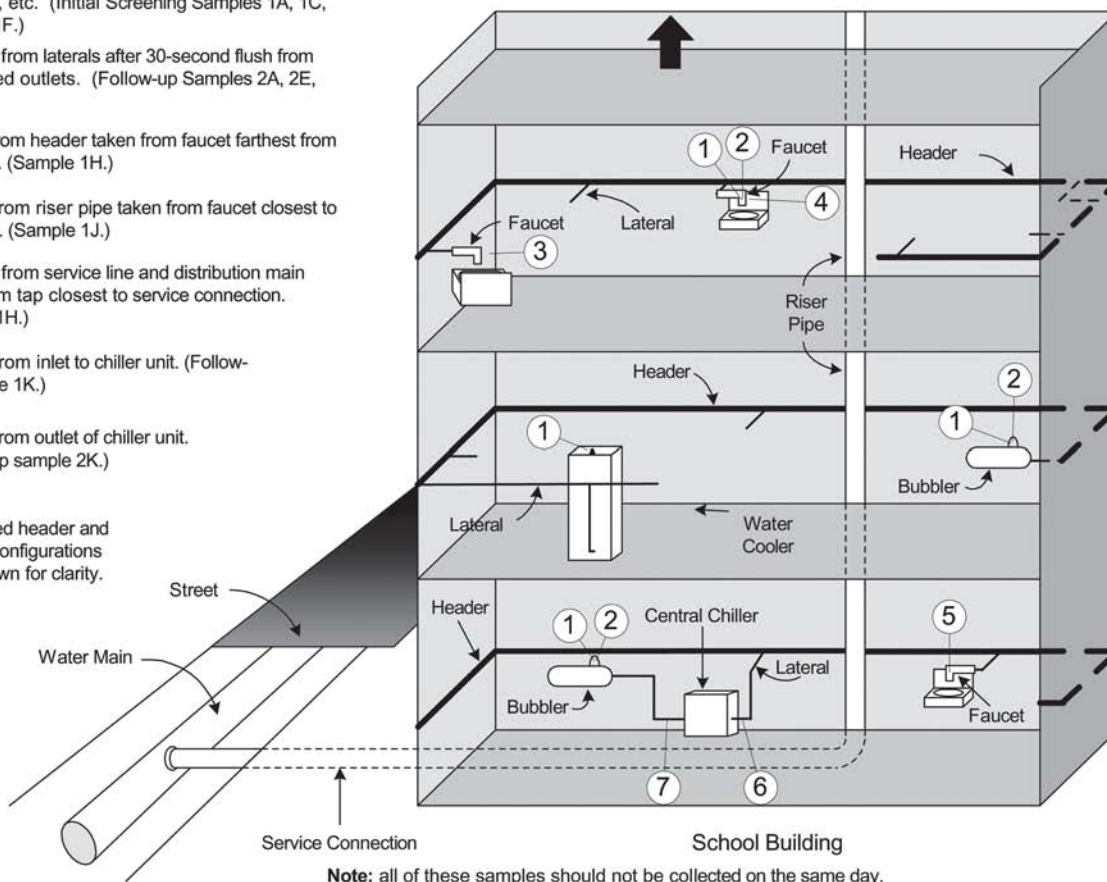

**Note:** all of these samples should not be collected on the same day.



## 5. Remedies

---

Solutions to lead problems typically need to be made on an interim (short-term) and on a permanent basis. Interim measures can be taken while you wait for your test results or until a permanent solution has been put in place. In addition, there are routine measures that should be taken. You should work closely with maintenance staff and any plumbers who may make repairs. Make sure that users are familiar with the use of new fixtures you install.

Outlined below are various routine, interim and permanent remedies. To aid you in the process of selecting remedies, a case study has been included as Exhibit 5.3.

### 5.1 Routine Control Measures

Below are examples of routine activities that should be conducted to prevent exposure to elevated levels of lead:

- Create aerator (screen) cleaning maintenance schedule and clean debris from all accessible aerators frequently.
- Use only cold water for food and beverage preparation. Hot water will dissolve lead more quickly than cold water and is likely to contain increased lead levels. If hot water is needed, it should be taken from the cold water tap and heated on a stove or in a microwave oven.
- Instruct the users (students and staff) to run the water before drinking or staff could run the water before students arrive, so they are drinking water that has not been in contact with the faucet interior since faucets are often a major source of lead in drinking water.
- Placard bathroom sinks with notices that water should not be consumed. You should use pictures if there are small children using bathrooms.

### 5.2 Interim (Short-Term) Control Measures

Some examples of interim control measures include:

- (1) **“Flush” the piping system in your building.** “Flushing” involves opening suspect taps every morning before the facility opens and letting the water run to remove water that has been standing in the interior pipes and/or the outlets. The flushing time varies by the type of outlet being cleared. The degree to which flushing helps reduce lead levels can also vary depending upon the age and condition of the plumbing and the corrosiveness of the water. Flushing instructions are presented in Exhibit 5.1.



## Exhibit 5.1: Flushing Directions by Outlet Type

Remember that each drinking water outlet should be flushed individually; flushing a toilet will not flush your water fountains. All flushing should be recorded in a log submitted daily to the office, or person, in charge of this program.

- Locate the faucet furthest away from the service line on each wing and floor of the building, open the faucets wide, and let the water run for 10 minutes. For best results, calculate the volume of the plumbing and the flow rate at the tap and adjust the flushing time accordingly. This 10-minute time frame is considered adequate for most buildings.
- Open valves at all drinking water fountains without refrigeration units and let the water run for roughly 30 seconds to one minute, or until cold.
- Let the water run on all refrigerated water fountains for 15 minutes. Because of the long time period required, routinely flushing refrigerated fountains may not be feasible. It may therefore be necessary, and more economical, to replace these outlets with lead-free, NSF-approved devices.
- Open all kitchen faucets (and other faucets where water will be used for drinking and/or cooking) and let the water run for 30 seconds to one minute, or until cold.

### Advantages:

- Quickest and easiest solution to high lead levels, especially when contamination is localized in a small area or in a small building.
- Does not require installation or maintenance of water treatment equipment.
- Does not require complex instructions.

### Disadvantages:

- The most obvious disadvantage to flushing is the potential waste of water involved in the flushing procedures. To minimize this disadvantage, consider the following:
  - ▶ Flush pipes only after weekends or vacations when lead levels may be highest (use only if lead levels do not exceed 20 ppb on a daily basis).
  - ▶ Thoroughly flush several designated drinking water outlets daily while taking all others temporarily out of service.
  - ▶ Use bottled water.
  - ▶ Collect water being flushed and use for non-consumptive purposes.
- Another obvious disadvantage to flushing is the amount of time and staff needed to perform the task.
- Flushing is not recommended as a practical remedy for water coolers.

**HINT:** Be careful not to flush too many taps at once. This could dislodge sediments that might create further lead problems, or it could reduce pressure in the system below safe levels. If the flow from outlets is reduced noticeably during flushing, you have probably turned on too many taps at once.

- (2) **Provide bottled water.** This can be an expensive alternative but might be warranted if you expect or are aware of widespread contamination and flushing is not an option. If you use bottled water, be aware that it is not regulated by EPA but rather by the Food and Drug Administration (FDA). Your state may also regulate bottled water, and, in some instances, these standards may be more stringent than the federal requirements. EPA recommends that you require a written statement from the bottled water distributor guaranteeing that the bottled water meets FDA and state standards.
- (3) **Shut off problem outlets.** If initial sample results from an outlet exceed 20 ppb, the outlet can be shut off or disconnected until the problem is resolved. If the outlet had been frequently used, bottled water could be provided as a temporary replacement as suggested in item 2 above.

### 5.3 Permanent Remedies

You can take a number of actions to permanently reduce or eliminate the sources of lead that originate in your building's plumbing. Some of these actions may allow the elimination or reduction of routine flushing or other interim measures. After obtaining an understanding of your water supply and the lead conditions in your facility (as a result of testing), you should examine the permanent treatment options and select those most appropriate to your situation. Obviously, your decision will be based on such factors as cost, likelihood of success, availability of water, and staffing requirements.

- (1) **Replacement.** If the sources of lead contamination are localized and limited to a few outlets, replacing these outlets or upstream components may be the most practical solution. EPA worked with the plumbing industry and NSF International to develop an industry standard that is designed to minimize the amounts of lead being leached from these products. This standard is NSF Standard 61 (Sections 4, 8 and 9). Before you purchase any brass plumbing products, request information regarding compliance with this standard.

*NSF Standard 61, Section 4* covers pipes, fittings and small drinking water storage devices having domestic or residential applications, including the products or water contact materials of pipes, fittings, tubing, hoses, well casing, drop pipes and screens, etc.

*NSF Standard 61, Section 8* covers inline mechanical devices that are used to measure or control the flow of water. Inline devices used to measure or control the flow of water in a building include water meters, building valves, check valves, meter stops, valves and fittings, backflow preventers, etc. An inline device is any device installed on a service line or building distribution system downstream of the water main and before endpoint devices.

*NSF Standard 61, Section 9* covers endpoint devices. The devices include kitchen and bar faucets, lavatory faucets, water dispensers, drinking fountains, water coolers, glass fillers, residential refrigerator ice makers, supply stops, and endpoint control valves. *Under the Lead Ban, these devices must meet the requirements of this standard.* Be sure to check for compliance with NSF Standard 61, Section 9 before purchasing or installing an endpoint device.

Tip: If multiple components (for example, bubbler valves) are in need of replacement, you may wish to purchase only one or two initially. You could then take follow-up water samples after installing the new component(s) to see if that particular product leaches unacceptable levels of lead. If follow-up testing is satisfactory, you could be reasonably certain that the product will perform well at other locations in your facility.

- (2) **Lead levels can be reduced at the tap.** Reverse osmosis units are commercially available and can be effective in removing lead. Since these devices also tend to make the water corrosive, they should only be used when placed at water outlets. Such devices are termed point-of-use (POU) devices. POU devices can be used to treat faucets or taps, but would not be used on drinking water fountains. There are a number of POU cartridge filter units on the market that effectively remove lead.

POU devices can be either purchased or leased. They can be relatively inexpensive (\$65 to \$250) or expensive (ranging from \$250 to \$500), their effectiveness varies, and they may be vulnerable to vandalism. They also require a maintenance program for regular upkeep to ensure effectiveness. Cartridge filter units need to be replaced periodically to remain effective. NSF International, an independent, third-party certification organization, has a testing program to evaluate the performance of POU devices for lead removal (NSF Standard 53). Before purchasing any device, ask the manufacturer for proof of NSF approval and the Performance Data Sheet, or check by visiting the NSF Web site at [http://www.nsf.org/business/search\\_listings/index/asp](http://www.nsf.org/business/search_listings/index/asp).

- (3) **Check grounding wires.** Electrical current may accelerate the corrosion of lead in piping materials. Existing wires already grounded to the water pipes can possibly be removed by a qualified electrician, and replaced by an alternative grounding system. If your local or state building codes allow, consider finding an alternative grounding system and have a qualified electrician make the change. Be aware that the removal of grounding from water pipes may create a shock hazard unless an acceptable, alternative ground is provided.
- (4) **Lead pipe replacement.** Lead pipes within the school and those portions of the lead service lines under the water supplier's jurisdiction can be replaced. Contact your public water supplier regarding their jurisdiction. However, your facility may be responsible for replacing a portion of a lead service line that is under its own administrative jurisdiction, rather than under the jurisdiction of the water supplier.
- (5) **Reconfigure plumbing.** In some facilities, the plumbing system might be modified so that water supplied for drinking or cooking is redirected to bypass sources of lead contamination. Before undertaking such an alternative, be certain of the sources of lead contamination. Follow-up testing would also be necessary, as with the other remedies, to ensure that the efforts result in reduced lead levels at the tap.
- (6) **Manual flushing.** Flushing individual problem outlets or all outlets may also represent a permanent, albeit ongoing, solution. There are advantages and disadvantages to flushing. Flushing is often the quickest and easiest solution to high lead levels, especially when contamination is localized in a small area or in a small building. *See the Interim Remedies section above for a discussion of the advantages/disadvantages of this remedy in addition to outlet flushing instructions. You should review this information before deciding whether flushing is appropriate as a permanent remedy in your facility.*
- (7) **Automatic flushing.** Time-operated solenoid valves can be installed and set to automatically flush the main pipes (headers) of the system. It is important to note that solenoid valves are not practical for flushing water coolers. They would have to be flushed manually by staff. *See the Interim Remedies section above for flushing instructions for water fountains.*
- (8) **Bottled water.** If other treatment fails or is impractical, bottled water can be purchased for consumption by the building community. As noted under the interim remedies section above, make sure that the bottled water you select meets federal and/or state standards for lead and other drinking

water contaminants. EPA recommends that you require a written statement from the bottled water distributor guaranteeing that the lead levels in the water do not exceed 5 ppb.

- (9) **Use lead-free materials.** Make sure that any plumber who does repair or replacement work on the facility's plumbing system uses only "lead-free" solders and other materials. The 1986 Safe Drinking Water Act Amendments require that only "lead-free" materials be used in new plumbing and plumbing repairs. Make sure all plumbers and other workers adhere to these requirements. These actions will ensure that new lead is not introduced into the facility's plumbing system. Report any violations of the "lead-free" requirements to your local plumbing inspector, the state drinking water program or EPA (*see Appendix D for a directory of state programs*).
- (10) **Shut off problem outlets.** If initial sample results from an outlet exceed 20 ppb, the outlet can be shut off or disconnected permanently. If the outlet had not been used regularly, this may be a viable option. However, if the outlet had been frequently used, this is probably not a practical solution.

Three flow charts (Exhibits 5.2a through 5.2c) illustrating a basic remediation process are presented below. Please note that these flow charts provide a basic process for developing permanent solutions to lead problems. Interim measures are therefore not specifically addressed on the charts. Also, for simplicity, not all of the possible permanent remedies listed in the above discussion are shown on the charts. However, these options provide additional flexibility and should be considered when using the flow charts. For example, a school might decide to provide a point-of-use reverse osmosis treatment unit at a kitchen sink tap in lieu of replacing high lead plumbing because a treatment unit would provide better overall water quality for cooking *and* it would remove lead from the water.

### Exhibit 5.2a: Remediation Flow Chart (part 1)

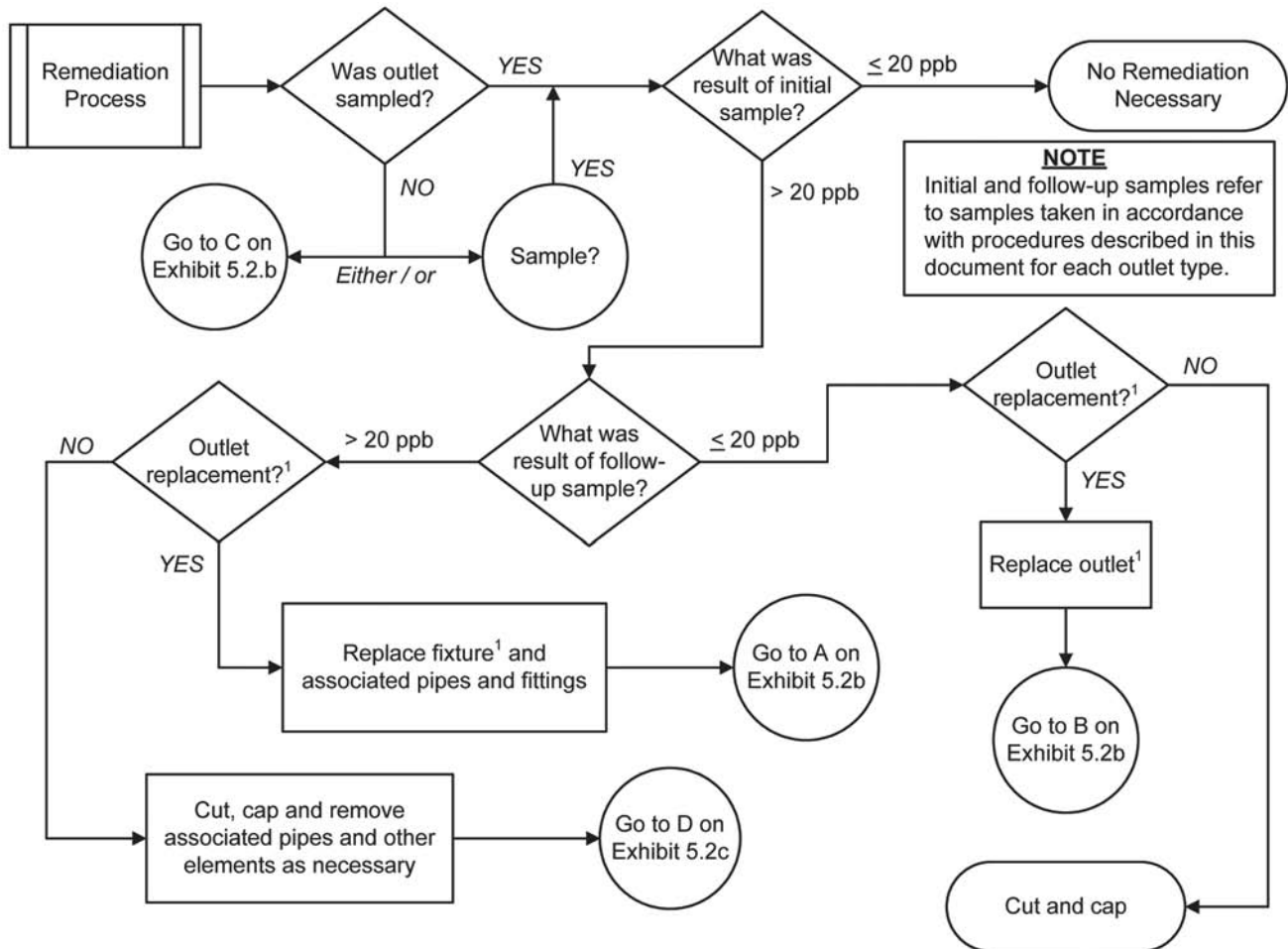

1 Point-of-use treatment devices or routine flushing measures may serve as alternatives to outlet replacement (see Section 5.3). Continue on with the flow chart.

### Exhibit 5.2b: Remediation Flow Chart (part 2)

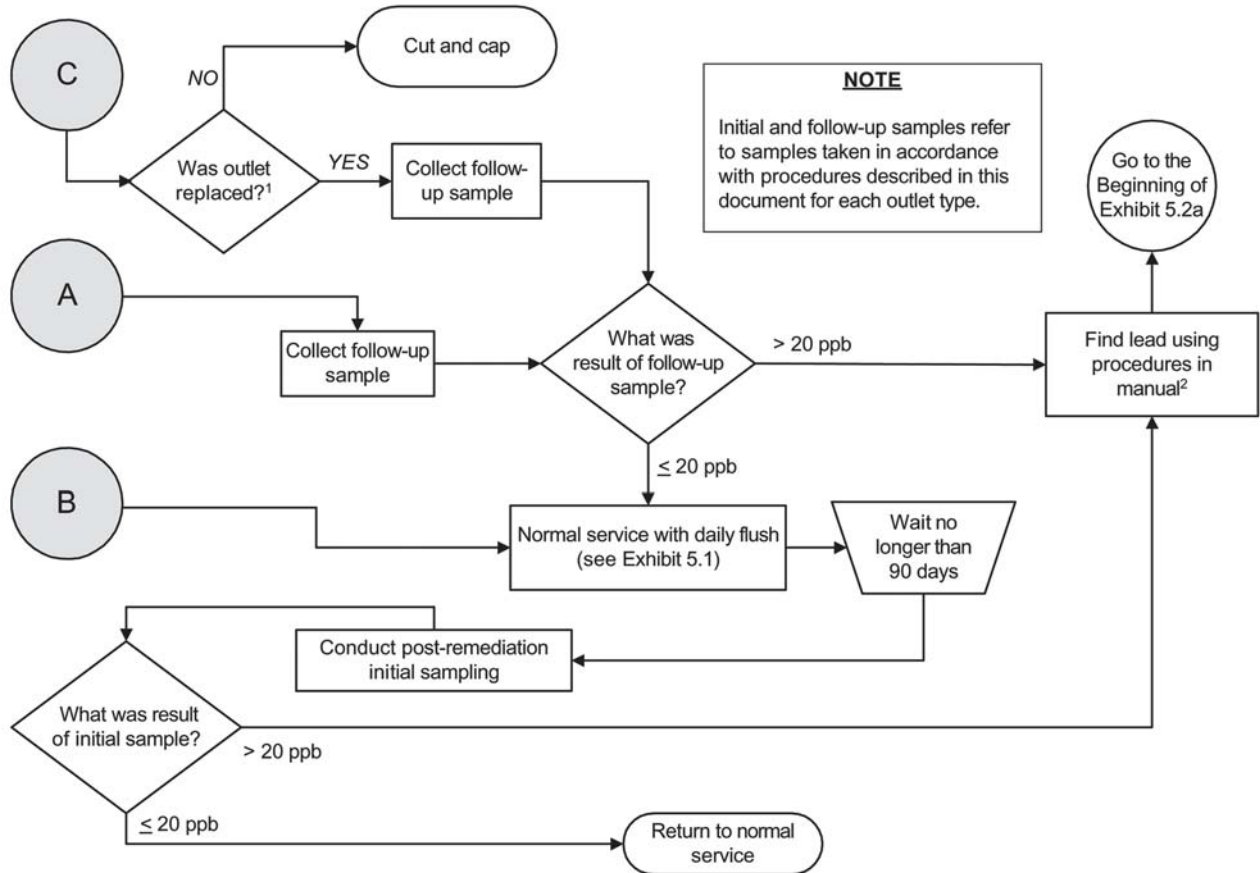

1 Point-of-use treatment devices or routine flushing measures may serve as alternatives to outlet replacement (see Section 5.3). Continue on with the flow chart.

2 Procedures include follow-up sampling and development of a plumbing profile (see Sections 3.1 and 4.4).

### Exhibit 5.2c: Remediation Flow Chart (part 3)

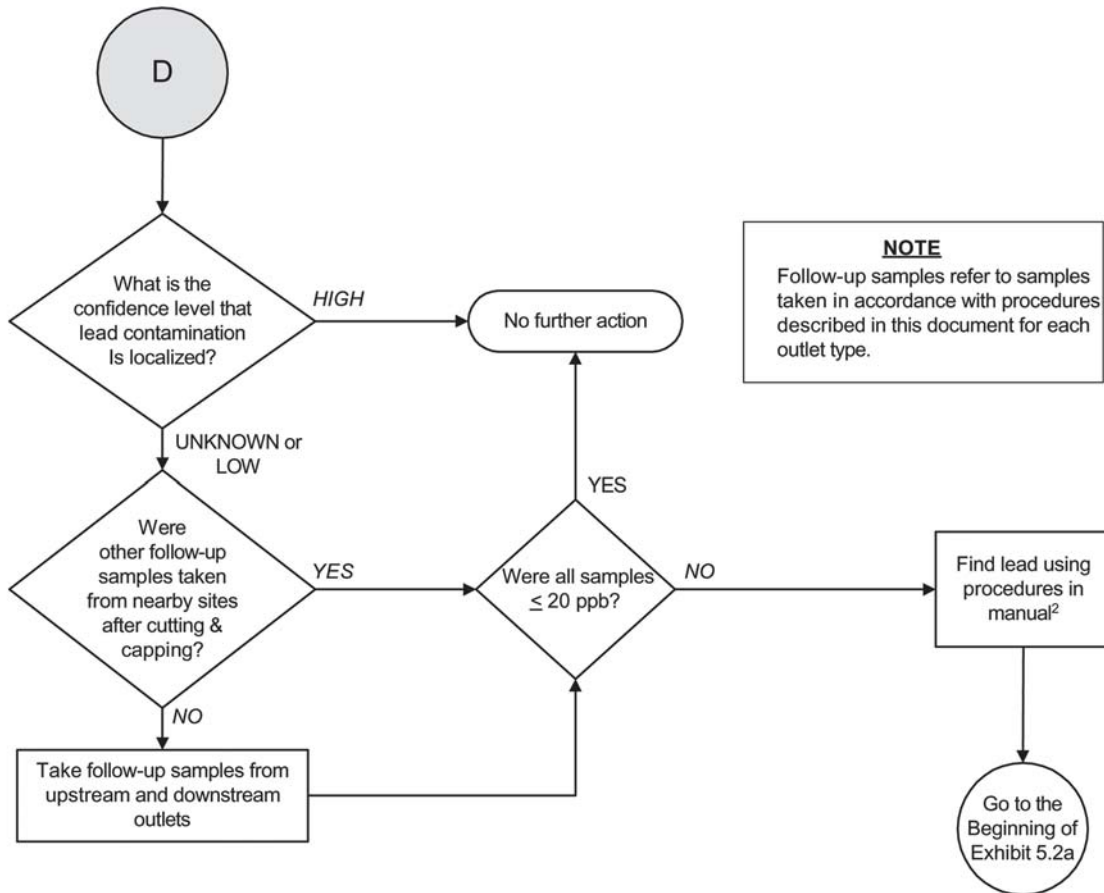

<sup>2</sup> Procedures include follow-up sampling and development of a plumbing profile (see Sections 3.1 and 4.4).



## Exhibit 5.3: Case Study 1

*This case study illustrates how one large school district addressed a long-standing lead problem. A variety of solutions were used to address lead problems at 50 schools in the district.*

### Background

Schools were sampled in 1991 and 1992 in response to the Lead Contamination Control Act. Drinking fountains with lead levels over 20 ppb were replaced. However, subsequent testing showed that levels at some outlets continued to be above 20 ppb. Internal recommendations to replace plumbing at four schools were not implemented due to many complex factors. A flushing program was implemented, but was not consistently applied.

In 2003, a concerned parent conducted testing at one school because of iron staining problems. The testing showed that there were also lead problems at the school. Recognizing that the problem was likely widespread, the district put all schools over 7 years old on bottled water and sent a letter of notification to every parent.

A consultant was hired to create a comprehensive testing program for almost 100 schools. A working group consisting of the school's local public water supplier, the county and state health departments, and toxicologists was formed to develop a comprehensive approach.

A comprehensive water quality policy was adopted that includes standards for lead and 5 other contaminants. The standard for lead (10 ppb) is more stringent than EPA's recommended Action Level for schools and public buildings. The policy includes procedures for short-term and long-term testing, and for remediation.

### Testing

In cooperation with the working group, the district's consultant developed plumbing profiles and a testing program, and the district began comprehensive lead testing in 2004 at 2400 sample locations. All drinking water fountains and cold water taps in classrooms, nurse's offices, and kitchens were sampled. Other locations were sampled if they were deemed to be a potential health risk because of possible human consumption. Lead levels over 20 ppb were found at 25% of the locations. One location was 1600 ppb. Fifty schools were found to have at least one outlet with a problem. The water supplied by the local public water system was found to have typically less than 1 ppb lead and was ruled out as a source of lead.

Testing also showed that flushing of the outlets for 30 seconds reduced the lead levels to below 20 ppb at all but 3% of the locations. Additionally, cadmium was found at 3% of the sample locations, and coliform-positive samples were found at 6 schools.

### Remediation

The district adopted a policy for mitigation that included a target level of 10 ppb for lead. Additionally, the EPA public water supply standards for cadmium, copper, iron and coliform bacteria were adopted. (The EPA standard for iron is a secondary standard, which means that the standard is primarily an aesthetic standard rather than health-based. Under federal law, public water supplies are not required to comply with secondary standards.) Compliance with the district's adopted standards will be maintained through fixture replacement, filtration, replacement/rehabilitation of lines, or disabling of outlets.

Fountains and other outlets that produce lead analysis results higher than 10 ppb will be fixed or disabled. Fixtures with confirmed levels of iron over 0.5 ppm will be fixed or removed from service. If more than one-

half of the drinking water sources in a school or in a wing of a school exceed 0.3 ppm iron, further remediation for iron will be addressed by the district.

The plumbing in the four schools originally targeted for replacement was fixed in the Summer of 2004. Eventually, the plumbing in all schools will be replaced or rehabilitated so the adopted water quality standards can be maintained. The approach used will range from complete piping replacement in just a few schools (no more than 7 total, including the 4 already done), to partial piping replacement in a number of schools (perhaps 15 total), to fixture replacement in many schools.

Bottled water is provided at all schools or locations within a school which have lead problems until problems are addressed. Drinking water is easily available to all students and all staff throughout the school day. After compliance with the adopted water quality standards is achieved, periodic testing will continue every three years until it is demonstrated that less frequent testing is necessary.

### **Public Education**

The district understands the importance of informing parents, students, and staff of water quality policy and testing results.

Additionally, the district adopted the following steps:

- Qualified experts were retained to obtain the best advice.
- A public oversight committee was created to ensure awareness and involvement of the public.
- Community meetings are held as necessary to keep the public updated.
- School board briefing sessions related to lead are open to the public.
- A comprehensive Web site has been developed that includes health effects information, FAQs, contact information, and testing results for each school in the district.

### **Lessons Learned**

The district had attempted to address the Lead Contamination Control Act in 1991 and 1992 through testing, replacement of drinking water fountains and flushing. Fountains that tested over 20 ppb were replaced until subsequent testing revealed that problems with lead persisted. Flushing efforts that were initially instituted were not uniformly implemented at all district schools. The district considered replacing plumbing in four schools, but no action was taken until 2004. The reasons for the work not being done are complex and no one reason can be cited. Additionally, there were no clear legal mandates for lead testing and compliance at schools served by public water utilities. Lead problems therefore continued at the schools without school officials' awareness.

Because remedial measures were not instituted as originally planned, the public was not aware that lead problems existed until 2003. The public response to the problems was very strong and clear. The public wanted to be aware of the problems and wanted them fixed. The school district had also lost credibility because of the amount of time, the inactivity, and the lack of communication since problems were initially discovered in the early 1990s.

The district has learned that clear, open, and timely communication is mandatory in order to restore public confidence. An aggressive policy of testing, remediation and disclosure has helped to bridge the gap between the district and the public and to restore confidence.

## III. Telling

### 6. Informing the Public about Lead

In addition to testing for lead and solving any contamination problems, a lead control program should also include a public information component. This section discusses public information techniques and the importance of developing an overall communication strategy. Helpful communication hints are provided along with sample public notice materials.

#### 6.1 Techniques for Disseminating Public Information

EPA recommends that schools conducting a lead-in-drinking-water sampling program comply with the public information components of the Lead Contamination Control Act. There are two components:

- (1) Notify relevant parent, teacher, student, and employee organizations of the availability of your sampling program results.
- (2) Make copies of the sampling results available in your administrative offices “for inspection by the public, including teachers, other school personnel, and parents.”

*Given the health effects of lead, EPA advocates that any school conducting sampling for lead make public any test results. In addition, such schools should identify activities they are pursuing to correct any lead problems found.*

There are six basic public notification methods that can be applied alone or in combination to communicate lead-in-drinking-water issues and the meaning of your sampling program results.

You should choose the method(s) that best suits your particular situation and/or protocol. Remember, you should not provide sampling program results to the public without also providing a basis for interpreting and understanding the significance of those results. All materials should be culturally and linguistically appropriate.

- **Press Release:** A press release in the local newspaper can potentially inform a broad range of the public of lead in drinking water issues and the results of your sampling program. It is important that the release inform readers of how to obtain the sampling results and other lead in drinking water information and perhaps even include the phone number of an informed and available facility official.
- **Letters/Fliers:** Letters or fliers represent the most direct and effective method of communicating lead in drinking water activities to parents/guardians and other members of your school or building community. The letters and fliers should be mailed directly.
- **Mailbox or Paycheck Stuffers:** Mailbox and paycheck stuffers represent the most direct and effective method of communicating lead in drinking water activities to school employees. Stuffers would contain much the same information as that contained in a press release or letter/flier.
- **Staff Newsletter:** A notice contained in a staff newsletter is another option for directly and effectively communicating information about the lead program to employees.

- **Presentations:** Providing presentations at facility-related meetings is another effective means of communication. Relevant events for schools include meetings of parent-teacher organizations, faculty, and the school board.
- **Email and Web sites:** Electronic communications are convenient for many parents, especially those who work during the school day. Web sites can be updated frequently to quickly convey new information. Email provides a quick, easy method for parents to ask questions, but responses must be timely to be effective.

## 6.2 The Components of an Effective General Communication Strategy

Lead in drinking water can be an emotional and sensitive issue, especially for parents who are concerned about their children's health. As a result, you should not view communication and outreach activities as stand-alone or final efforts, but rather as a part of an *overall or general* communication strategy.

The purpose of a general communication strategy is to provide the means for addressing questions from members of your facility's community and also to provide ongoing, up-to-date information regarding your sampling efforts. *Ideally, you should designate a single spokesperson or special task force to interact with the public since it is important that your message remain consistent.*

The issues to be addressed as part of a communication strategy include:

- Participants
- Timing for delivery
- Content of the message
- Methods and manner of communication.

## 6.3 Participants

Overall, there are six primary players or interests involved in the control of lead in drinking water:

- (1) **Your School Community:** School employees, students, and parents should be informed and involved from the beginning of the process. Interested employees, students, and parent volunteers can help address the issue and ensure safe drinking water at your school.
- (2) **Building Community:** The building community consists of those users of the facility who would be most affected by lead in drinking water problems (i.e., students, teachers and other employees, school boards and community groups who use the facility). Members of the school and building community should be the primary targets of any general communication activities.
- (3) **Local Health Community:** Local health officials, such as health officers, sanitarians, and nurses, can help you understand potential health risks associated with elevated lead levels in drinking water.
- (4) **Larger Community:** The local and regional media can serve as a conduit for information reaching a larger local community. It is important that you be prepared to generate accurate news releases. Also, your spokesperson or task force should be prepared to respond to interview requests with accurate and consistent information.

- (5) **States and EPA Regions:** State drinking water programs and EPA Regional offices are responsible for ensuring that public water suppliers comply with the state and federal regulations regarding lead in drinking water. States or EPA may be able to provide guidance or technical assistance in communication strategies, health risks, and other sources of lead.
- (6) **Drinking Water Community:** Public water suppliers comprise the regulated drinking water community, and they are responsible for complying with all national and state drinking water standards for lead. This means that they must ensure that the water they deliver is non-corrosive, contains minimal amounts of lead, and will not result in significant lead-leaching from plumbing in individual homes and buildings.

## 6.4 Timing

The timing of your communication activities is very important. Whenever public health risks are involved, public communication efforts are less complicated and generate less conflict if those potentially affected are notified in advance of important issues and events. At a minimum, EPA recommends that you provide information to members of the local school community and the larger community (if deemed necessary) at the following three times.

- (1) Before your lead in drinking water sampling program begins.
- (2) In response to periodic interest.
- (3) After you obtain the results of testing, when/if you decide upon corrective measures, or if no corrective measure are required because the lead levels are low.

## 6.5 Content

Your communication messages should consist of the following information:

- (1) Details about the nature of your drinking water lead control program.
- (2) The results of your sampling program and your plans for correcting any identified problems.
- (3) Information on the public health effects and risks posed by lead in drinking water and the significance of lead in drinking water versus other sources such as food, air, dust, and soil.
- (4) The availability of general lead in drinking water information resources and the availability of the detailed sampling results for your facility.
- (5) How and where individuals may seek blood-lead level testing if they are concerned.
- (6) Recommend consultation with a physician if further assistance is needed.
- (7) How families can increase their awareness of exposure in their home and elsewhere.

## 6.6 Methods and Manner of Communication

The communication methods that can be used for your general communication strategy are largely the same as those described earlier and, thus, need not differ from communication activities common to school operations (i.e., meeting presentations, press releases, mailbox/paycheck stuffers, and letters to staff and parents). If your school has a large community of non-English speakers you should provide information in other languages, as appropriate, or provide a contact name for non-English speakers to get more information.

Additional methods unique to your lead control program may include:

- (1) Creating an information center located at a convenient place in the facility such as a library or break room.
- (2) Creating a task force with representatives from the community.
- (3) Making available a list of laboratories that are state-certified to test home water for lead and other contaminants.
- (4) (For schools) encouraging classroom science activities that focus on drinking water quality. (*Contact EPA's Safe Drinking Water Hotline 1-800-426-4791— see Appendix B and C — for information on organizations that have such science activities*).

The following list contains some hints for effective communication:

- (1) Take the initiative in providing information to your community (it is important to do so before the media does it for you). When public health risks are involved, especially with respect to children, vague or incorrect information can be worse than no information at all.
- (2) Be a good and reliable source of information. That is, provide honest, accurate, and comprehensive information in every necessary area.
- (3) Always speak with one voice (i.e., designate points of contact – preferably one person – to respond to parents and the media).
- (4) Anticipate likely questions from members of the local community, including civic organizations and the media, and prepare answers. Each member of the community may have a different concern or viewpoint on the subject of lead testing.
- (5) Be positive, proactive, and forthcoming when working with the media. If you work together in a cordial manner, your communication efforts are likely to be less complex.
- (6) Keep members of the building community up-to-date as important events and information on your lead testing program unfold.

## 6.7 Sample Public Notice Materials

Exhibit 6.1 contains a sample public notification letter that could be used and adapted to communicate lead testing information. Exhibit 6.2 is a sample press release for local media that could also be used or adapted. Exhibit 6.3 is a sample article that could be published in a school newsletter.

## Exhibit 6.1: Sample Public Notice Letter

(Date)

Anytown School Department  
Anytown, USA 00000-0000

Dear Anytown School Community:

Our school system is committed to protecting student, teacher, and staff health. To protect our community, (Anytown School District) tests our schools' drinking water for lead.

### Why Test School Drinking Water for Lead?

High levels of lead in drinking water can cause health problems. Lead is most dangerous for pregnant women, infants, and children under 6 years old. Exposure to high levels of lead during pregnancy contributes to low birth weight and developmental delays in infants. In young children, lead exposure can lower IQ levels, affect hearing, reduce attention span, and hurt school performance. At *very* high levels, lead can even cause brain damage.

To protect public health, the U.S. Environmental Protection Agency (EPA) suggests that schools and day care facilities test their drinking water for lead. If lead is found at any water outlet at levels above 20 parts per billion (ppb), EPA recommends taking action to reduce the lead.

### Is Our School's Drinking Water Safe?

Yes, our schools' water is safe. Anytown School District tested our drinking water for lead. Of the (number) water samples we tested, only (number) showed lead levels above the 20 ppb mark. In other words, (percentage) of the water outlets tested did not have any lead problems.

The first outlet with high lead levels was a drinking water fountain/bubbler at (Anytown High School). We identified the source of the lead so we could fix the problem. The faucet for this drinking water fountain/bubbler was made of lead parts. (Lead was often used in plumbing materials until it was banned in 1986). We replaced the part with a lead-free faucet. Then we tested the water again and found the problem was fixed.

The second outlet with high lead levels was a faucet in the kitchen of (Anytown Elementary School). We found the source of the lead was a pipe that brings water to the faucet. We replaced the pipe with lead-free pipe. Then we tested the water again and found the problem was fixed.

While we sampled the schools' water, we provided bottled water for all students and staff. When we found high lead levels at (two) water outlets, we made sure no one used those outlets until we had fixed the lead problems.

### How Can I Learn More?

You can see a copy of all of our water testing results at the school district's central office, which is open Monday to Friday from (9:00 am to 5:00 pm) and on our Web site at (www.anytownschools.k12.us). For more information about water quality in our schools, please contact (John Doe) at (Anytown School District, 555-2233). For information about water quality and sampling for lead at home, contact your local water supplier or state drinking water agency.

Sincerely,

(Fred Frank)  
Superintendent of Schools

*Note: If your school district cannot immediately fix elevated lead levels, we encourage you to send this notice without delay. In that case, describe the interim measures you will take to provide safe drinking water until the problem can be addressed and the reason for the delay in implementing a permanent solution.*



## Exhibit 6.2: Sample Press Release for Local Media

Anytown School Department  
One School Street  
Anytown, USA 00000-0000  
Contact: Fred Frank, Superintendent

### FOR IMMEDIATE RELEASE

#### News Release

#### Lead Levels in School Drinking Water Meet Federal Guidelines

Anytown, USA, April xx, 2005... The Anytown School Department announced today that recent tests of drinking water in the town's schools indicate that lead levels meet federal guidelines. Although lead was initially detected above the recommended level at one drinking water outlet in an elementary school and at one outlet in a senior high school, lead levels were reduced to acceptable levels following replacement of these outlets.

In making the announcement, School Superintendent Fred Frank stated, "We are pleased that the testing program identified only two drinking water outlets with elevated lead levels. Both outlets have since been replaced."

The School Department conducted the testing program to make sure that drinking water in the school system is safe for children and school staff. Water with high lead levels can contribute to negative health effects, especially in young children.

The testing was conducted in January by school personnel following federal and state guidelines. Samples from various locations in each of the schools were sent to a state-certified laboratory for analysis. The laboratory results were received by the School Department last week.

Information about the lead testing program, including the laboratory results, can be found at the School Department office at the above address, weekdays between 8:30 a.m. and 4:30 p.m.

**STOP**

## Exhibit 6.3: Sample Newsletter Article

### Anytown School District Conducts Sampling for Lead in Drinking Water

#### Why was Testing Conducted?

Schools that receive water from a public water system, such as our district, are not required by state or federal regulations to conduct testing for lead in their drinking water. The Environmental Protection Agency (EPA) requires our public water system to provide water to our school that is minimally corrosive. However, some school districts in other locations have found that water samples from their drinking water fixtures have contained relatively high levels of lead. The lead was found to come from the plumbing inside the schools, including fittings, solder, water coolers or water faucets. Because of this information, the Anytown School District decided that testing would be in the best interests of the children, parents, faculty and other citizens served by our district.

#### Health Effects of Lead

The EPA has determined that lead in drinking water is a health concern at certain levels of exposure. Lead is found throughout the environment in lead-based paint, air, soil, household dust, food, certain types of pottery porcelain and pewter, and water. Lead can pose a significant risk to your health if too much of it enters your body. Lead builds up in the body over many years and can cause damage to the brain, red blood cells and kidneys. The greatest risk is to young children and pregnant women. Amounts of lead that will not hurt adults can slow down normal mental and physical development of growing bodies. In addition, a child at play often comes into contact with sources of lead contamination - like dirt and dust - that rarely affect an adult. It is important to wash children's hands and toys often, and to try to make sure they only put food in their mouths.

#### How Lead Enters our Water

Lead is unusual among drinking water contaminants in that it seldom occurs naturally in water supplies like groundwater, rivers and lakes. Lead enters drinking water primarily as a result of the corrosion, or wearing away, of materials containing lead in the water distribution system and in building plumbing. These materials include lead-based solder used to join copper pipe, brass, and chrome-plated brass faucets. In 1986, Congress banned the use of lead solder containing greater than 0.2% lead, and restricted the lead content of faucets, pipes and other plumbing materials. However, even the lead in plumbing materials meeting these new requirements is subject to corrosion. When water stands in lead pipes or plumbing systems containing lead for several hours or more, the lead may dissolve into the drinking water. This means the first water drawn from the tap in the morning *may* contain fairly high levels of lead.

#### Lead in Drinking Water

Lead in drinking water, although rarely the sole cause of lead poisoning, can significantly increase a person's total lead exposure, particularly the exposure of children under the age of 6. EPA estimates that drinking water can make up 20% or more of a person's total exposure to lead.

#### Results of our Testing

Following instructions given in an EPA guidance document especially designed for schools, we completed a plumbing profile for each of the buildings within the Anytown School District. Through this effort, we identified and tested those drinking water outlets most likely to have high levels of lead. Of the \_\_\_\_ samples taken, all but \_\_\_\_ tested well below EPA's recommended level of 20 ppb for lead.

The first outlet that tested high for lead was a drinking water fountain (bubbler) at Kennedy High School. After follow-up testing was conducted, it was determined that the faucet (bubbler head) was the source of the lead contamination. The faucet was replaced with a lead-free faucet and retested. Follow-up test results revealed lead levels well below EPA's recommended level.

(Continued on next page)

(Continued from previous page)

The second outlet, in the Lincoln Elementary School, was a faucet in the kitchen that showed unacceptable lead levels in both initial and follow-up testing. We found the source of the lead contamination to be the pipe providing water to the faucet. This pipe was replaced with lead-free materials.

During the testing period, bottled water was provided to all students at all schools to minimize the potential for lead exposure. Upon receiving the test results, the two outlets that tested high for lead were disconnected until they were replaced.

A copy of the test results is available in our central office for inspection by the public, including students, teachers, other school personnel, and parents, and can be viewed between the hours of 8:30 a.m. and 4:00 p.m. For more information about water quality in our schools, contact John Doe at the Anytown School Department, 555-2223. For information about water quality in your home or for questions about testing, contact your water supplier or drinking water agency.

## **Appendix A – Glossary of Terms**

**Bubbler:** An outlet fixture that consists of the bubbler valve, the bubbler receptacle and all associated piping, valves and mounting appurtenances for attaching the fixture to a wall or mounting surface. A bubbler does not contain a refrigeration unit. Some bubblers are attached to central chiller units, while others are not.

**Bubbler Valve:** The valve and discharge device that mounts on top of the bubbler fixture and discharges water for consumption.

**Chiller:** A central refrigeration unit providing cold water to some types of bubblers.

**Corrosion:** A dissolving and wearing away of metal caused by a chemical reaction (e.g., between water and the piping that the water contacts).

**Drinking Water Fountain:** A fixture connected to the water supply that provides water as needed. There are four types of drinking water fountains: (1) bubblers without central chillers, (2) bubblers with central chillers, (3) water coolers, and (4) bottled water dispensers.

**Faucet (“tap”):** A valved outlet device attached to a pipe that normally serves a sink or tub fixture. A faucet discharges hot and/or cold water for a variety of consumptive uses, including drinking, cooking, and washing. The term “faucet” is used interchangeably with the term “tap.”

**Fittings:** Fittings are generally static parts that are used to join sections of pipe, or to join pipe to outlet fixtures.

**Flux:** A substance applied during soldering to facilitate the flow of solder. Flux often contains lead and can itself be a source of lead contamination in water. The lead-free requirements of the 1986 Safe Drinking Water Act Amendments require that solders and flux not contain more than 0.2 percent lead.

**Header:** The main pipe in the internal plumbing system of a building. The header supplies water to lateral pipes.

**Lateral:** A plumbing branch between a header or riser pipe and a fixture or group of fixtures. A lateral may or may not be looped. Where more than one fixture is served by a lateral, connecting pipes are provided between the fixtures and the lateral.

**Lead-free:** Taken from Section 1417(d) of the Safe Drinking Water Act, this term means that solders and flux may not contain more than 0.2 percent lead; pipes, pipe fittings, and well pumps may not contain more than 8.0 percent lead; and outlet plumbing fittings and fixtures must meet standards established under the lead leaching requirements of section 1417(e) of the Safe Drinking Water Act.

**Outlet:** A location where water may be accessed for consumption such as a drinking fountain, water faucet, or tap.

**Passivation:** A corrosion control technique that causes the pipe materials to create metal-hydroxide-carbonate compounds that form a film on the pipe wall to protect the pipe.

**Potable Water Pipes:** The pipes in a distribution system and in a building which carry water intended for human consumption.

**Public Water System:** Any water system that has 15 or more service connections and is in operation at least 60 days per year or any water system serving 25 or more persons daily at least 60 days per year.

**Riser:** The vertical pipe that carries water from one floor to another.

**Sediment:** Matter from piping or other water conveyance device that settles to the bottom of the water in the apparatus. If lead components are used in plumbing materials, lead sediments may form and result in elevated water lead levels.

**Service Connection:** The pipe that carries tap water from the public water main to a building. In the past, these were often comprised of lead materials.

**Source Water:** Untreated water from streams, rivers, lakes, or underground aquifers that is used to supply private wells and public drinking water.

**Solder:** A metallic compound used to seal the joints between pipes. Until 1988, solder containing up to 50% lead was legally used in potable water plumbing. Lead-free solders, which can contain up to 0.2% lead, often contain one or more of the following metals: antimony, tin, copper or silver. Several alloys are available that melt and flow in a manner similar to lead solder.

**Valves:** Valves are any of numerous mechanical devices by which the flow of water may be started, stopped, or regulated by a movable part that opens, shuts, or partially obstructs one or more ports of passageway.

**Water Cooler:** Any mechanical device affixed to drinking water supply plumbing that actively cools water for human consumption. The reservoir can consist of a small tank or a pipe coil.

## **Appendix B – Publication List**

### Web Site Publications\*

- (1) *\*Actions You Can Take To Reduce Lead in Drinking Water.* Web site publication. US EPA 810-F-93-001. June 1993. <http://www.epa.gov/safewater/lead/leadfactsheet.html>
- (2) *Commonly Asked Questions: Section 1417 of the Safe Drinking Water Act and the NSF Standard.* US EPA. <http://www.epa.gov/safewater/standard/plumbing.html>
- (3) *Consumer Fact Sheet on: Lead.* Web site article. US EPA. <http://www.epa.gov/safewater/dwh/c-ioc/lead.html>
- (4) *Decision Tree for Pre-Sampling* (at Schools). Web site article. US EPA. <http://www.epa.gov/safewater/schools>
- (5) *\*Fact Sheet - Lead Reduction Plan - EPA Activities to Improve Implementation of the Lead and Copper Rule.* Web site publication. US EPA 810-F-05-001. March 2005. [http://www.epa.gov/safewater/lcrmr/reductionplan\\_fs.html](http://www.epa.gov/safewater/lcrmr/reductionplan_fs.html)
- (6) *Frequently Asked Questions.* Web site article. National Sanitation Foundation (NSF). [http://www.nsf.org/business/water\\_distribution/dwa\\_usepa.asp](http://www.nsf.org/business/water_distribution/dwa_usepa.asp)
- (7) *\*Is There Lead in the Drinking Water?* Web site publication. US EPA 903-F-01-002. April 2002. <http://www.epa.gov/safewater/lead/pdfs/v2final.pdf>
- (8) *\*Lead Contamination Control Act* (pamphlet). Web site article. Web site publication. US EPA 570/9-89-AAA. July 1989. <http://www.epa.gov/safewater/lead/pdfs/epalccapamphlet1989.pdf>
- (9) *Lead Contamination Control Act* (statute). Web site article. Government Printing Office. January 2004. [http://www.access.gpo.gov/uscode/title42/chapter6a\\_subchapterxii\\_partf.html](http://www.access.gpo.gov/uscode/title42/chapter6a_subchapterxii_partf.html)
- (10) *\*Lead in Drinking Water in Schools and Non-Residential Buildings.* Web site publication. US EPA 812-B-94-002. (April 1994 version of this document.)

- (11) *Lead in Schools and Day Care Centers*. Web site article. US EPA.) <http://www.epa.gov/safewater/lead/schoolanddccc.htm>
- (12) *Mechanical Plumbing System Components*. Web site article. Listing of approved components. NSF. [http://www.nsf.org/business/mechanical\\_plumbing/index.asp?program=MechanicalPluSysCom](http://www.nsf.org/business/mechanical_plumbing/index.asp?program=MechanicalPluSysCom)
- (13) *National Lead Information Center - Document Request Site*. US EPA. <http://www.epa.gov/lead/nlicdocs.htm>
- (14) *Post-Remediation Sampling*. Web site article. (after replacement of fixtures, pipe, fittings, etc.). US EPA. <http://www.epa.gov/safewater/lead/passivation.htm>
- (15) *Testing Schools and Day Care Centers for Lead in Drinking Water*. Web site article. US EPA. <http://www.epa.gov/safewater/lead/testing.htm>
- (16) \**Lead Contamination Control Act* (P.L. 100-572 - federal statute) and supporting documents. House Document Room, House of Representatives. Washington, DC 20515. (202) 225-3456.
- (17) \**Sampling for Lead in Drinking Water in Nursery Schools and Day Care Facilities* (booklet). US EPA 812-B-94-003. April 1994.
- (18) \**The Lead Ban: Preventing the Use of Lead in Public Water Systems and Plumbing Used for Drinking Water* (pamphlet on the federal lead ban). US EPA 570/9-89-BBB. August 1989.

\* Also available in hard copy through the National Drinking Water Hotline. See below.

### Hard Copy Publications

EPA National Safe Drinking Water Hotline  
(800) 426-4791

Hotline operates Monday through Friday,  
except federal holidays.



## **Appendix C – Resources**

Safe Drinking Water Hotline 1-800-426-4791

### **Healthy School Environments**

#### **Healthy School Environments**

This web site is designed to provide one-stop access to the many programs and resources available to help prevent and resolve environmental issues in schools. <http://www.epa.gov/schools/>

#### **Department of Education Safe and Drug Free Schools**

This Department of Education web site offers a collection of links and resources on various school health and safety topics. <http://www.ed.gov/admins/lead/safety/edpicks.jhtml?src=qc>

### **Lead Poisoning Prevention**

#### **Lead Poison Prevention**

EPA's Lead Awareness Program designs outreach activities and educational materials, awards grants, and manages a toll-free hotline to help parents, home owners, and lead professionals learn what they can do to protect their families, and themselves, from the dangers of lead. <http://www.epa.gov/lead/>

#### **The Centers for Disease Control Childhood Lead Poisoning Prevention Program**

The Lead Contamination Control Act of 1988 authorized the Centers for Disease Control and Prevention (CDC) to initiate program efforts to eliminate childhood lead poisoning in the United States. Visit this web site for information on partnerships, publications, and various other materials addressing lead poison prevention. <http://www.cdc.gov/nceh/lead/lead.htm>

#### **National Lead Information Center (NLIC)**

The National Lead Information Center (NLIC) provides the general public and professionals with information about lead hazards and their prevention. NLIC operates under a contract with the U.S. Environmental Protection Agency (EPA), with funding from EPA, the Centers for Disease Control and Prevention, and the Department of Housing and Urban Development. (1-800-424-LEAD [5323]). <http://www.epa.gov/lead/nlic.htm>

### **Accredited Certification Programs:**

**American National Standards Institute:** list of accredited plumbing and other product certification programs. [www.ansi.org/public/ca/ansi\\_cp.html](http://www.ansi.org/public/ca/ansi_cp.html)

The current companies/organizations with NSF 61 plumbing component certification programs accredited by ANSI:

**National Sanitation Foundation:** Also provides information on the standards that it has issued. [www.nsf.org](http://www.nsf.org)

**Underwriters Laboratories.** [www.ul.com](http://www.ul.com)

**International Association of Plumbing & Mechanical Officials, Research & Testing, Inc.** [www.iapmo.org/rnt/index.html](http://www.iapmo.org/rnt/index.html)

**Canadian Standards Association International.** [www.csa.ca](http://www.csa.ca)

**Truesdail Laboratories.** [www.truesdail.com](http://www.truesdail.com)

## **Appendix D – List of State Drinking Water Programs**

### **Alabama**

Mr. Ed Hughes, Chief  
Drinking Water Branch  
Dept. of Environmental Management  
P.O. Box 301463  
Montgomery, AL 36130-1463  
Phone: 334-271-7774  
Fax: 334-279-3051  
E-mail: [ekh@adem.state.al.us](mailto:ekh@adem.state.al.us)

### **Alaska**

Dr. James Weise, Manager  
Drinking Water Program  
Division of Environmental Health  
Alaska Dept. of Environmental Conservation  
555 Cordova St.  
Anchorage, AK 99501  
Phone: 907-269-7647  
Fax: 907-269-7655  
E-mail: [james\\_weise@dec.state.ak.us](mailto:james_weise@dec.state.ak.us)

### **American Samoa**

Ms. Sheila Wiegman, Environmental  
Coordinator  
American Samoa  
Environmental Protection Agency  
Office of the Governor  
Pago Pago, AS 96799  
Phone: 684-633-2304  
Fax: 684-633-5801

### **Arizona**

Mr. John Calkins  
Drinking Water Section  
Arizona Dept. of Environmental Quality  
1110 W. Washington St.  
Phoenix, AZ 85007  
Phone: 602-771-4617  
Fax: 602-771-4634  
E-mail: [calkins.john@azdeq.gov](mailto:calkins.john@azdeq.gov)

### **Arkansas**

Mr. Harold R. Seifert, P.E., Director  
Division of Engineering  
Arkansas Department of Health  
4815 West Markham Street  
Mail Slot 37  
Little Rock, AR 72205-3867  
Phone: 501-661-2623  
Fax: 501-661-2032  
E-mail: [hseifert@HealthyArkansas.com](mailto:hseifert@HealthyArkansas.com)

### **California**

Dr. David P. Spath, Chief  
Division of Drinking Water  
and Environmental Management  
California Dept. of Health Services  
P.O. Box 997413  
Sacramento, CA 95899-7413  
Phone: 916-449-5582  
Fax: 916-449-5575  
E-mail: [DSpath@dhs.ca.gov](mailto:DSpath@dhs.ca.gov)

### **Colorado**

Mr. Chet Pauls, Manager  
Drinking Water Program  
Water Quality Control Division  
Colorado Dept. of Public Health and  
Environment  
WQCD-DW-B2  
4300 Cherry Creek Drive, South  
Denver, CO 80246-1530  
Phone: 303-692-3610  
Fax: 303-782-0390  
E-mail: [chester.pauls@state.co.us](mailto:chester.pauls@state.co.us)

**Connecticut**

Dr. Gerald R. Iwan, Director  
 Drinking Water Division  
 Connecticut Dept. of Public Health  
 410 Capitol Ave. MS-51WAT  
 P.O. Box 340308  
 Hartford, CT 06134-0308  
 Phone: 860-509-7333  
 Fax: 860-509-7359  
 E-mail: gerald.iwan@po.state.ct.us

**Delaware**

Mr. Edward G. Hallock, Program  
 Administrator  
 Office of Drinking Water  
 Division of Public Health  
 Delaware Health and Social Services  
 Blue Hen Corporate Center, Suite 203  
 655 Bay Road  
 Dover, DE 19901  
 Phone: 302-741-8590  
 Fax: 302-741-8631  
 E-mail: edward.hallock@state.de.us

**District of Columbia**

Ms. Jerusalem Bekele, Chief  
 Water Quality Division  
 Department of Health  
 51 N Street, NE  
 Washington, DC 20002  
 Phone: 202-535-1603  
 E-mail: jerusalem.bekele@dc.gov

**Florida**

Mr. Van R. Hoofnagle, Administrator  
 Drinking Water Section  
 Florida Dept. of Environmental Protection  
 Twin Towers Office Building  
 2600 Blair Stone Road  
 Tallahassee, FL 32399-2400  
 Phone: 850-245-8631  
 Fax: 850-245-8669  
 E-mail: van.hoofnagle@dep.state.fl.us

**Georgia**

Mr. Nolton G. Johnson, Chief  
 Water Resources Branch  
 Environmental Protection Div., Georgia DNR  
 2 Martin Luther King, Jr. Drive, S.E.  
 East Tower - Suite 1362  
 Atlanta, GA 30334  
 Phone: 404-651-5168  
 Fax: 404-651-9590  
 E-mail:  
 nolton\_johnson@mail.dnr.state.ga.us  
 \*Mr. Brad Addison is Manager  
 of the Drinking Water Program  
 (see address above)  
 Phone: 404-651-5155  
 Fax: 404-651-9590  
 E-mail: brad\_addison@dnr.state.ga.us

**Guam**

Mr. Jesus T. Salas, Administrator  
 Guam Environmental Protection Agency  
 Government of Guam  
 P.O. Box 22439 GMF  
 Barrigada, GU 96921  
 Phone: 671-472-8863  
 Fax: 671-477-9402

**Hawaii**

Mr. Thomas E. Arizumi, Chief  
 Environmental Management Division  
 Hawaii Department of Health  
 919 Ala Moana Blvd.  
 Room 300  
 Honolulu, HI 96814-4920  
 Phone: 808-586-4304  
 Fax: 808-586-4352  
 E-mail:  
 tarizumi@eha.health.state.hi.us

\*Mr. Bill Wong is the Chief of  
 the Safe Drinking Water Branch  
 (see address above, except Room 308)  
 Phone: 808-586-4258  
 Fax: 808-586-4351  
 E-mail: waterbill@aol.com

## Idaho

Mr. Lance E. Nielsen, Manager  
Drinking Water Program  
Idaho Dept. of Environmental Quality  
1410 North Hilton  
Boise, ID 83706  
Phone: 208-373-0291  
Fax: 208-373-0576  
E-mail: lance.nielsen@deq.idaho.gov

## Illinois

Mr. Roger D. Selburg, P.E., Manager  
Division of Public Water Supplies  
Illinois EPA  
P.O. Box 19276  
Springfield, IL 62794-9276  
Phone: 217-785-8653  
Fax: 217-782-0075  
E-mail: roger.selburg@epa.state.il.us

## Indiana

Mr. Patrick Carroll, Chief  
Drinking Water Branch  
Office of Water Quality  
Dept. of Environmental Management  
P.O. Box 6015  
Indianapolis, IN 46206-6015  
Phone: 317-308-3281  
Fax: 317-308-3339  
E-mail: pcarroll@idem.in.gov

## Iowa

Mr. Dennis J. Alt, Environmental Program  
Supervisor  
Water Supply Section  
Iowa Department of Natural Resources  
401 SW 7th Street, Suite M  
Des Moines, IA 50309-4611  
Phone: 515-725-0275  
Fax: 515-725-0348  
E-mail: dennis.alt@dnr.state.ia.us  
\*Mr. Steve Hopkins is Supervisor of  
the Water Supply Operations  
(see address above)  
Phone: 515-725-0295  
Fax: 515-725-0348  
E-mail: stephen.hopkins@dnr.state.ia.us

## Kansas

Mr. David F. Waldo, Chief  
Public Water Supply Section  
Bureau of Water  
Kansas Dept of Health & Environment  
1000 SW Jackson St. - Suite 420  
Topeka, KS 66612-1367  
Phone: 785-296-5503  
Fax: 785-296-5509  
E-mail: dwaldo@kdhe.state.ks.us

## Kentucky

Ms. Donna S. Marlin, Manager  
Division of Water - Drinking Water Branch  
Kentucky Dept. for Environmental Protection  
14 Reilly Road, Frankfort Ofc. Park  
Frankfort, KY 40601  
Phone: 502-564-3410  
Fax: 502-564-5105  
E-mail: donna.marlin@ky.gov

## Louisiana

Ms. Karen Irion, Administrator  
Safe Drinking Water Program  
Center for Environmental and Health  
Services  
Office of Public Health  
Louisiana Dept. of Health and Hospitals  
6867 Blue Bonnet Blvd.  
Baton Rouge, LA 70810  
Phone: 225-765-5046  
Fax: 225-765-5040  
E-mail: Kirion@dhh.la.gov

## Maine

Ms. Nancy Beardsley, Director  
Drinking Water Program  
Maine Department of Health and Human  
Services  
Division of Health Engineering  
11 State House Station  
Augusta, ME 04333  
Phone: 207-287-5674  
Fax: 207-287-4172  
E-mail: nancy.beardsley@maine.gov

**Maryland**

Mr. Saeid Kasraei, Manager  
 Water Supply Program  
 Maryland Dept. of the Environment  
 Montgomery Park Business Center  
 1800 Washington Blvd. - Suite 450  
 Baltimore, MD 21230-1708  
 Phone: 410-537-3702  
 Fax: 410-537-3157  
 E-mail: skasraei@mde.state.md.us

**Massachusetts**

Mr. David Terry, Director  
 Drinking Water Program  
 Massachusetts Department of  
 Environmental  
 Protection  
 One Winter Street, 6th Floor  
 Boston, MA 02108  
 Phone: 617-292-5529  
 Fax: 617-292-5696  
 E-mail: david.terry@state.ma.us

**Michigan**

Mr. James K. Cleland, P.E., Chief  
 Water Bureau  
 Michigan Dept. of Env. Quality  
 P. O. Box 30630  
 Lansing, MI 48909-8130  
 Phone: 517-241-1287  
 Fax: 517-335-0889  
 E-mail: clelandj@michigan.gov

**Minnesota**

Mr. Doug Mandy, Manager  
 Drinking Water Protection Section  
 Minnesota Department of Health  
 Metro Square Building, Suite 220  
 P.O. Box 64975  
 St. Paul, MN 55164-0975  
 Phone: 651-215-0757  
 Fax: 651-215-0775  
 E-mail: douglas.mandy@health.state.mn.us

**Mississippi**

Mr. Keith Allen, Director  
 Division of Water Supply  
 Mississippi State Department of Health  
 P.O. Box 1700  
 570 E. Woodrow Wilson Dr.  
 Jackson, MS 39215-1700  
 Phone: 601-576-7518  
 Fax: 601-576-7822  
 E-mail: kallen@msdh.state.ms.us

**Missouri**

Mr. Ed Galbraith, Director  
 Water Protection Program  
 Missouri Dept of Natural Resources  
 P.O. Box 176  
 Jefferson City, MO 65102  
 Phone: 573-751-6721  
 Fax: 573-751-1146  
 E-mail: ed.galbraith@dnr.mo.gov

**Montana**

Mr. Jon Dillard, Bureau Chief  
 Public Water and Subdivisions Bureau  
 Montana Dept. of Environmental Quality  
 Box 200901  
 1520 East Sixth Ave.  
 Helena, MT 59620-0901  
 Phone: 406-444-4071  
 Fax: 406-444-1374  
 E-mail: jdillard@mt.gov

**Nebraska**

Mr. Jack L. Daniel, Administrator  
 Environmental Health Services Section  
 Nebraska Health and Human Services  
 System  
 301 Centennial Mall South, 3rd Floor  
 P.O. Box 95007  
 Lincoln, NE 68509-5007  
 Phone: 402-471-0510  
 Fax: 402-471-6436  
 E-mail: jack.daniel@hhss.ne.gov

## **Nevada**

Mr. Andrew Huray, Chief  
Public Health Engineering Section  
Nevada State Health Division  
1179 Fairview Drive  
Carson City, NV 89701  
Phone: 775-687-6353  
Fax: 775-687-5699  
E-mail: ahuray@nvhd.state.nv.us

## **New Hampshire**

Mr. Rene Pelletier, Program Manager  
Water Supply Engineering Bureau  
Dept. of Environmental Services  
Post Office Box 95  
6 Hazen Drive  
Concord, NH 03302-0095  
Phone: 603-271-3434  
Fax: 603-271-5171  
E-mail: rpelletier@des.state.nh.us  
\* Ms. Sarah Pillsbury is Drinking Water  
Administrator  
(see address above)  
Phone: 603-271-1168  
Fax: 603-271-2181  
E-mail: spillsbury@des.state.nh.us

## **New Jersey**

Mr. Barker Hamill, Chief  
Bureau of Safe Drinking Water  
New Jersey Department of Environmental  
Protection  
P.O. Box 426  
Trenton, NJ 08625  
Phone: 609-292-5550  
Fax: 609-292-1654  
E-mail: barker.hamill@dep.state.nj.us

## **New Mexico**

Mr. Fernando Martinez, Chief  
Drinking Water Bureau  
New Mexico Environment Department  
525 Camino De Los Marquez  
Suite 4  
Santa Fe, NM 87505  
Phone: 505-827-1400  
Fax: 505-827-7545  
E-mail:  
fernando\_martinez@nmenv.state.nm.us

## **New York**

Mr. Jack Dunn, Director  
Bureau of Public Water Supply Protection  
New York Department of Health  
Flanigan Square, Rm. 400  
547 River Street  
Troy, NY 12180-2216  
Phone: 518-402-7650  
Fax: 518-402-7659  
E-mail: jmd02@health.state.ny.us

## **North Carolina**

Ms. Jessica G. Miles, P.E., Chief  
Public Water Supply Section  
North Carolina Dept. of Env. and Natural  
Resources  
1634 Mail Service Center  
Raleigh, NC 27699-1634  
Phone: 919-715-3232  
Fax: 919-715-4374  
E-mail: jessica.miles@ncmail.net

## **North Dakota**

Mr. Larry J. Thelen, Program Manager  
Drinking Water Program  
ND Dept. of Health  
1200 Missouri Avenue, Room 203  
P.O. Box 5520  
Bismarck, ND 58506-5520  
Phone: 701-328-5257  
Fax: 701-328-5200  
E-mail: lthelen@state.nd.us

## Northern Mariana Islands

Mr. John I. Castro, Director  
 Division of Environmental Quality  
 Commonwealth of the Northern Mariana Islands  
 Post Office Box 501304  
 Saipan, MP 96950-1304  
 Phone: 670-664-8500  
 Fax: 670-664-8540  
 E-mail: deq.director@saipan.com  
 \*Mr. Joe M. Kaipat is the Manager of  
 the Safe Drinking Water Branch  
 (see address above)  
 Phone: 670-664-8500  
 Fax: 670-664-8540  
 E-mail: joe.kaipat@saipan.com

## Ohio

Mr. Mike G. Baker, Chief  
 Division of Drinking and Ground Waters  
 Ohio EPA  
 Lazarus Gov't Center  
 P.O. Box 1049  
 Columbus, OH 43216-1049  
 Phone: 614-644-2752  
 Fax: 614-644-2909  
 E-mail: mike.baker@epa.state.oh.us  
 \*Mr. Kirk Leifheit is Assistant Chief of  
 Drinking Water in the  
 Division of Drinking and Ground Waters  
 (see address above)  
 Phone: 614-644-2769  
 Fax: 614-644-2909  
 E-mail: kirk.leifheit@epa.state.oh.us

## Oklahoma

Mr. Jon L. Craig, Director  
 Water Quality Division  
 Department of Environmental Quality  
 707 North Robinson  
 Suite 8100  
 P.O. Box 1677  
 Oklahoma City, OK 73101-1677  
 Phone: 405-702-8100  
 Fax: 405-702-8101  
 E-mail: jon.craig@deq.state.ok.us

\*Mr. Mike S. Harrell is Administrator of  
 the Public Water Supply Program  
 (see address above)  
 Phone: 405-702-8158  
 Fax: 405-702-8101  
 E-mail: mike.harrell@deq.state.ok.us

## Oregon

Mr. David E. Leland, Manager  
 Drinking Water Program  
 Office of Public Health Systems  
 Oregon Department of Human Services  
 800 NE Oregon St. - Rm. 611  
 Portland, OR 97232  
 Phone: 503-731-4010  
 Fax: 503-731-4077  
 E-mail: david.e.leland@state.or.us

## Pennsylvania

Mr. Jeffrey A. Gordon, Chief  
 Division of Operations Management and Training  
 Bureau of Water Standards and Facility  
 Regulation  
 Department of Environmental Protection  
 P.O. Box 8467  
 Harrisburg, PA 17105-8467  
 Phone: 717-772-4018  
 Fax: 717-772-3249  
 E-mail: jegordon@state.pa.us

## Puerto Rico

Ms. Olga Rivera, Director  
 Public Water Supply Supervision Program  
 Puerto Rico Department of Health  
 Office of the Secretary  
 Nacional Plaza Building  
 431 Ponce De Leon Ave.  
 9th Floor - Suite 903  
 Hato Rey, PR 00917  
 Phone: 787-648-3903  
 Fax: 787-758-6285  
 E-mail: orivera@salud.gov.pr



## Rhode Island

Ms. June A. Swallow, P.E., Chief  
Office of Drinking Water Quality  
Rhode Island Department of Health  
3 Capitol Hill, Room 209  
Providence, RI 02908  
Phone: 401-222-6867  
Fax: 401-222-6953  
E-mail: junes@doh.state.ri.us

## South Carolina

Mr. Alton C. Boozer, Chief  
Bureau of Water  
South Carolina Dept. of Health &  
Environmental Control  
2600 Bull Street  
Columbia, SC 29201  
Phone: 803-898-4259  
Fax: 803-898-3795  
E-mail: boozerac@dhec.sc.gov

## South Dakota

Mr. Rob Kittay, Administrator  
Drinking Water Program  
Division of Environmental Regulation  
SD Dept. of Env. and Natural Resources  
523 East Capital Ave, Joe Foss Bldg  
Pierre, SD 57501-3181  
Phone: 605-773-4208  
Fax: 605-773-5286  
E-mail: rob.kittay@state.sd.us

## Tennessee

Mr. W. David Draughon, Jr., Director  
Division of Water Supply  
Tennessee Dept. of Environment &  
Conservation  
401 Church Street  
L & C Tower, 6th Floor  
Nashville, TN 37243-1549  
Phone: 615-532-0152  
Fax: 615-532-0503  
E-mail: david.draughon@state.tn.us

## Texas

Mr. E. Buck Henderson, Manager  
Public Drinking Water Section  
Water Supply Division  
Texas Commission on  
Environmental Quality  
P.O. Box 13087 (MC – 155)  
Austin, TX 78711-3087  
Phone: 512-239-0990  
Fax: 512-239-0030  
E-mail: ehenders@tceq.state.tx.us

## Utah

Mr. Kevin W. Brown, Director  
Division of Drinking Water  
Utah Dept. of Environmental Quality  
P.O. Box 144830  
Salt Lake City, UT 84114-4830  
Phone: 801-536-4188  
Fax: 801-536-4211  
E-mail: kwbrown@utah.gov

## Vermont

Mr. Jay L. Rutherford, P.E., Director  
Water Supply Division  
Vermont Dept. of Env. Conservation  
Old Pantry Building  
103 South Main Street  
Waterbury, VT 05671-0403  
Phone: 802-241-3434  
Fax: 802-241-3284  
E-mail: jay.rutherford@state.vt.us

## Virgin Islands

Mr. Leonard Reed, Assistant Director  
Division of Environmental Protection  
Dept. of Planning & Natural Resources  
Wheatley Center 2  
St. Thomas, VI 00802  
Phone: 340-777-4577  
Fax: 340-774-5416  
\* Mrs. Christine M. Lottes is Supervisor of Public  
Water System Supervision (PWSS)  
Dept. of Planning & Natural Resources  
Water Gut Homes 1118  
Christiansted, St. Croix, VI 00820-5065  
Phone: 340-773-0565  
Fax: 340-773-9310

**Virginia**

Mr. Jerry Peaks, Director  
 Office of Drinking Water  
 Virginia Department of Health  
 109 Governor St.  
 Richmond, VA 23219  
 Phone: 804-864-7488  
 Fax: 804-864-7520  
 E-mail: jerry.peaks@vdh.virginia.gov

**Washington**

Ms. Denise Addotta Clifford, Director  
 Office of Drinking Water  
 WA Department of Health  
 7211 Cleanwater Lane, Bldg. 9  
 P.O. Box 47828  
 Olympia, WA 98504-7828  
 Phone: 360-236-3110  
 Fax: 360-236-2253  
 E-mail: denise.clifford@doh.wa.gov

**West Virginia**

Mr. Walter Ivey, Director  
 Environmental Engineering Div.  
 Office of Environmental Health Services  
 West Virginia Dept. of Health and Human  
 Services  
 815 Quarrier Street, Suite 418  
 Charleston, WV 25301  
 Phone: 304-558-6715  
 Fax: 304-558-0289  
 E-mail: walterivey@wvdhhr.org

**Wisconsin**

Ms. Jill D. Jonas, Director  
 Bureau of Drinking Water and Groundwater  
 Wisconsin Department of Natural Resources  
 P.O. Box 7921  
 Madison, WI 53707  
 Phone: 608-267-7545  
 Fax: 608-267-7650  
 E-mail: jill.jonas@dnr.state.wi.us

**Wyoming**

Mr. John Wagner, Administrator  
 Water Quality  
 Dept. of Environmental Quality  
 Herschler Building  
 4th Floor West  
 Cheyenne, WY 82002  
 Phone: 307-777-7055  
 Fax: 307-777-5973  
 E-mail: jwagne@state.wy.us  
 \*Wyoming's Drinking Water Program is managed by  
 EPA Region VIII

## Appendix E – Water Cooler Summary

The Lead Contamination Control Act (LCCA), which amended the Safe Drinking Water Act, was signed into law on October 31, 1988 (P.L. 100-572). The potential of water coolers to supply lead to drinking water in schools and child care centers was a principal focus of this legislation. Specifically, the LCCA mandated that the Consumer Product Safety Commission (CPSC) order the repair, replacement, or recall and refund of drinking water coolers with lead-lined water tanks. In addition, the LCCA called for a ban on the manufacture or sale in interstate commerce of drinking water coolers that are not lead-free. Civil and criminal penalties were established under the law for violations of this ban. With respect to a water cooler that may come in contact with drinking water, the LCCA defined the term “lead-free” to mean:

“not more than 8 percent lead, except that no drinking water cooler which contains any solder, flux, or storage tank interior surface which may come in contact with drinking water shall be considered lead-free if the solder, flux, or storage tank interior surface contains more than 0.2 percent lead.”

Another component of the LCCA was the requirement that EPA publish and make available to the states a list of drinking water coolers, by brand and model, that are not lead-free. In addition, EPA was to publish and make available to the states a separate list of the brand and model of water coolers with a lead-lined tank. EPA is required to revise and republish these lists as new information or analyses become available.

Based on responses to a Congressional survey in the winter of 1988, three major manufacturers, the Halsey Taylor Company, EBCO Manufacturing Corporation, and Sunroc Corporation, indicated that lead solder had been used in at least some models of their drinking water coolers. On April 10, 1988, EPA proposed in the *Federal Register* (at 54 *FR* 14320) lists of drinking water coolers with lead-lined tanks and coolers that are not lead-free. Public comments were received on the notice, and the list was revised and published on January 18, 1990 (Part III, 55 *FR* 1772). See *Table E-2 for a list of water coolers and lead components*.

Prior to publication of the January 1990 list, EPA determined that Halsey Taylor was the only manufacturer of water coolers with lead-lined tanks.<sup>1</sup> Table E-1 presents a listing of model numbers of the Halsey Taylor drinking water coolers with lead-lined tanks that had been identified by EPA as of January 18, 1990.

<sup>1</sup>Based upon an analysis of 22 water coolers at a US Navy facility and subsequent data obtained by EPA, EPA believes the most serious cooler contamination problems are associated with water coolers that have lead-lined tanks.

Since the LCCA required the CPSC to order manufacturers of coolers with lead-lined tanks to repair, replace or recall and provide a refund of such coolers, the CPSC negotiated such an agreement with Halsey Taylor through a consent order published on June 1, 1990 (at 55 *FR* 22387). The consent agreement calls on Halsey Taylor to provide a replacement or refund program that addresses all the water coolers listed in Table E-2 as well as “all tank-type models of drinking water coolers manufactured by Halsey Taylor, whether or not those models are included on the present or on a future EPA list.” Under the consent order, Halsey Taylor agreed to notify the public of the replacement and refund program for all tank type models.

***SPECIAL NOTE:***

Experience indicates that newly installed brass plumbing components containing 8 percent or less lead, as allowed by the SDWA, can contribute high lead levels to drinking water for a considerable period after installation. U.S. water cooler manufacturers have notified EPA that since September 1993, the components of water coolers that come in contact with drinking water have been made with non-lead alloy materials. These materials include stainless steel for fittings and water control devices, brass made of 60 percent copper and 40 percent zinc, terillium copper, and food grade plastic.

Currently, a company formerly associated with Halsey Taylor, Scotsman Ice Systems, has assumed responsibility for replacement of lead-line coolers previously marketed by Halsey Taylor. See below for the address of Scotsman Ice Systems.

Scotsman Ice Systems  
775 Corporate Woods Parkway  
Vernon Hills, IL 60061  
PH: (800) SCOTSMAN or 800-726-8762  
PH: (847) 215-4500

**Table E-1**  
**Halsey Taylor Water Coolers With Lead-Lined Tanks<sup>2</sup>**

The following six model numbers have one or more units in the model series with lead-lined tanks:

WM8A      WT8A      GC10ACR      GC10A      GC5A      RWM13A

The following models and serial numbers contain lead-lined tanks:

<u>WM14A Serial No.</u> 843034	<u>WM14A Serial No.</u> 843006	<u>WT11A Serial No.</u> 222650
<u>WT21A Serial No.</u> 64309550	<u>WT21A Serial No.</u> 64309542	<u>LL14A Serial No.</u> 64346908

<sup>2</sup>Based upon an analysis of 22 water coolers at a US Navy facility and subsequent data obtained by EPA, EPA believes the most serious cooler contamination problems are associated with water coolers that have lead-lined tanks.

**Table E-2**  
**Water Coolers With Other Lead Components**

**EBCO Manufacturing**

All pressure bubbler water coolers with shipping dates from 1962 through 1977 have a bubbler valve containing lead. The units contain a single, 50-50 tin-lead solder joint on the bubbler valve. Model numbers for coolers in this category are not available.

The following models of pressure bubbler coolers produced from 1978 through 1981 contain one 50-50 tin-lead solder joint each.

<u>CP3</u>	<u>DP15W</u>	<u>DPM8</u>	<u>7P</u>	<u>13P</u>	<u>DPM8H</u>	<u>DP15M</u>	<u>DP3R</u>	<u>DP8A</u>
<u>DP16M</u>	<u>DP5S</u>	<u>C10E</u>	<u>PX-10</u>	<u>DP7S</u>	<u>DP13SM</u>	<u>DP7M</u>	<u>DP7MH</u>	<u>DP7WMD</u>
<u>WTC10</u>	<u>DP13M-60</u>	<u>DP14M</u>	<u>CP10-50</u>	<u>CP5</u>	<u>CP5M</u>	<u>DP15MW</u>	<u>DP3R</u>	<u>DP14S</u>
<u>DP20-50</u>	<u>DP7SM</u>	<u>DP10X</u>	<u>DP13A</u>	<u>DP13A-50</u>	<u>EP10F</u>	<u>DP5M</u>	<u>DP10F</u>	<u>CP3H</u>
<u>CP3-50</u>	<u>DP13M</u>	<u>DP3RH</u>	<u>DP5F</u>	<u>CP3M</u>	<u>EP5F</u>	<u>13PL</u>	<u>DP8AH</u>	<u>DP13S</u>
<u>CP10</u>	<u>DP20</u>	<u>DP12N</u>	<u>DP7WM</u>	<u>DP14A-50/60</u>				

**Halsey Taylor**

1. Lead solder was used in these models of water coolers manufactured between 1978 and the last week of 1987:

<u>WMA-1</u>	<u>SCWT/SCWT-A</u>	<u>SWA-1</u>	<u>DC/DHC-1</u>
<u>S3/5/10D</u>	<u>BFC-4F/7F/4FS/7FS</u>	<u>S300/500/100D</u>	

2. The following coolers manufactured for Haws Drinking Faucet Company (Haws) by Halsey Taylor from November 1984 through December 18, 1987, are not lead-free because they contain 2 tin-lead solder joints. The model designations for these units are as follows:

<u>HC8WT</u>	<u>HC14F</u>	<u>HC6W</u>	<u>HWC7D</u>	<u>HC8WTH</u>	<u>HC14F</u>	<u>HC8W</u>	<u>HC2F</u>	<u>HC14WT</u>
					<u>H</u>			
<u>HC14FL</u>	<u>HC14W</u>	<u>HC2FH</u>	<u>HC14WTH</u>	<u>HC8FL</u>	<u>HC4F</u>	<u>HC5F</u>	<u>HC14WL</u>	<u>HCBF7D</u>
<u>HC4FH</u>	<u>HC10F</u>	<u>HC16WT</u>	<u>HCBF7HO</u>	<u>HC8F</u>	<u>HC8FH</u>	<u>HC4W</u>	<u>HWC7</u>	

If you have one of the Halsey Taylor water coolers noted in Table E-2, contact Scotsman Ice Systems (*address and phone noted above*) to learn more about the requirements surrounding their replacement and rebate program.

## Appendix F – Sample Recordkeeping Form

### Appendix F – Sample Recordkeeping Form

#### Record of Sampling

Name of Building

Name of Sample Collector

Contact Person for this Record

--	--	--	--

Sample ID Number

Circle sample type: Initial / 1<sup>st</sup> Follow-up / 2<sup>nd</sup> Follow-up

Length of Flush (for flushed samples)

Type of Outlet (faucet, cooler etc.)

Mfg/Model

Serial #

Date of Installation

Location

Date of Collection

Time of Collection

Name of Laboratory Used

Lead Concentration (ppb)

**NOTES:**

## **Appendix G - Preservation of Samples and Sample Containers**

This appendix contains information pertaining to the preservation of samples and sample containers. A certified drinking water laboratory should be aware of these requirements. In addition, they will provide you with actual samplers or sample containers and instructions. The sample containers may have been prepared prior to your receipt. The laboratory will also specify how to handle the sample containers and when to submit them after taking your samples.

In order to avoid analytical errors, pay particular attention to proper collection and handling of the sample before analysis. Sample containers (250 mL) should be obtained from a certified laboratory. You should not use other containers such as used jars or water bottles.

Make sure the containers are kept sealed between the time of their preparation by the lab and the collection of the sample. This will assure that no contaminants from the outside are introduced. Preserve the sample by icing and promptly ship or deliver it to the laboratory. Most laboratories will provide the necessary shipping containers and cold packs. Upon receipt, the laboratory will acidify the sample. The sample can be held up to 14 days prior to acidification without loss of lead through absorption, but EPA recommends that the laboratories receive the samples as soon as possible.

For more detailed information, refer to the following documents:

*Methods for the Determination of Metals in Environmental Samples.* EPA/600/4-94/111. May 1994 (available from the National Technical Information Service, Pub. No. PB95-125472 (703) 487-4650).

*Manual for the Certification of Laboratories Analyzing Drinking Water.* US EPA 815-B-97-001. March 1997 (available from the National Technical Information Service (703) 487-4650).

*Standard Methods for the Examination of Water and Wastewater, 20<sup>th</sup> Edition.* Co-published by the American Public Health Association, the Water Environment Federation, and the American Water Works Association. 1998 (available from the American Water Works Association, ISBN # 0-87553-235-7, Catalog #10079).



## Appendix H – Example Scenarios for Water Sample Results

### Service Connection Sampling (See Exhibit 4.3)

#### Examples:

- Sample 1S (20 ppb) exceeds Sample 1M (5 ppb) = 15 ppb of lead is contributed from the service connection; the lead amount in the main (Sample 1M) does not exceed 5 ppb; therefore, you may want to check for a lead service line or gooseneck depending upon results of lead testing at other outlets in the building; if you reduce lead at the connection, lead levels may be reduced throughout the remainder of the building.
- Sample 1M is 10 ppb and Sample 1S is 10 ppb = very little lead is contributed from the service line; source of lead is most likely the water main.
- Sample 1S (7 ppb) and Sample 1M (6 ppb) are close to 5 ppb = very little lead (1 ppb) is being picked up in the water from the service line or the distribution main; very little lead is contributed from the source water; if other outlets show significantly higher lead levels, the source of the contamination is the interior plumbing and/or the outlets themselves.

### Drinking Water Fountain without Central Chiller (See Exhibit 4.4)

#### Example:

- Sample 1A (31 ppb) exceeds Sample 2A (7 ppb) = 24 ppb of lead is contributed from the bubbler.
- Sample 2A (7 ppb) does not significantly exceed 5 ppb = very little lead (2 ppb) is being picked up from the plumbing upstream from the bubbler; the majority of the lead in the water is contributed from the bubbler.
- Sample 2A (7 ppb) does not exceed 20 ppb = sampling from header or loop supplying water to the lateral is not necessary.

**Possible Solution:** Replace fixture, valves, or fittings on bubbler with lead-free device (ensure compliance with the NSF standards for any fixtures you intend to purchase); retest water for lead after new materials installed.

## Drinking Water Fountain with Central Chiller (See Exhibits 4.4 and 4.9)

### Example 1:

- Sample 1A (25 ppb) exceeds Sample 2A (3 ppb) = 22 ppb of lead is contributed from the bubbler.
- Sample 2A (3 ppb) is close to 5 ppb = very little lead is being picked up from the plumbing upstream from the bubbler; the majority or all of the lead is contributed from the bubbler.

**Possible Solution:** Replace bubbler valve, fittings and/or fixture with lead-free materials (request results of lead leaching studies from manufacturers of brass products before purchasing to ensure that harmful amounts of lead will not be leached); retest water once new materials installed.

### Example 2:

- Sample 1A (38 ppb) exceeds Sample 2A (21 ppb) = 17 ppb of lead is contributed from the bubbler.
- Sample 2A (21 ppb) significantly exceeds 5 ppb = about 21 ppb of lead is being contributed from the plumbing upstream from the bubbler.
- Sample 2A (21 ppb) exceeds 20 ppb = sampling from the chiller unit supplying the water to the lateral is necessary to locate the source of the contamination (see *instructions and examples below for sampling chiller units*).

### Example 3:

- Sample 2A (21 ppb) exceeds Sample 2K (10 ppb) = 11 ppb of lead is contributed from the plumbing supplying the water from the chiller to the bubbler.
- Sample 2K (10 ppb) exceeds Sample 1K (4 ppb) = a portion of the lead (6 ppb) may be coming from the chiller; check for and remove any debris and sludge in the chiller unit; flush the unit, and resample the water.
- Sample 1K (4 ppb) does not exceed 20 ppb = additional sampling from the distribution system supplying water to the chiller is not necessary.
- Sample 1K (4 ppb) is very close to 5 ppb = very little lead is picked up from the plumbing upstream from the chiller; the majority or all of the lead in the water can be attributed to the chiller and the plumbing downstream from the chiller.

**Possible Solutions:** Flush the chiller unit and plumbing; if lead levels are still high, replace plumbing supplying water from the chiller to the bubbler; replace the bubbler fixture, fittings, and valves with lead-free materials; and clean sediment and debris from chiller unit. Retest water for lead once changes have been made. If the lead levels after initial flushing are low, clean any sediment and debris from the chiller, and resample the chiller monthly for 3 months. If the lead levels increase, the additional remediation measures listed immediately above are probably necessary to reduce lead risks. If the levels remain low, routine annual cleaning of sediment and debris and routine monitoring at the same frequency as other sites is recommended .

### Example 4:

- Sample 2A (45 ppb) exceeds Sample 2K (28 ppb) = 17 ppb of lead is being contributed from the plumbing supplying water from the chiller to the bubbler.
- Sample 2K (28 ppb) exceeds Sample 1K (21 ppb) = 7 ppb of lead is contributed by the chiller.
- Sample 1K (21 ppb) exceeds 20 ppb = additional sampling from the distribution system supplying water to the chiller is necessary to locate the source of the contamination (see *Exhibit 4.9 on Sampling Interior Plumbing for instructions*).

**Possible Solution:** Lead levels are clearly elevated at all sample sites. It appears that multiple sources of lead are contributing to the problem. Retesting may help locate sources of lead, but it appears that the solution includes replacement of upstream plumbing; the bubbler fixture, valves, and fittings with lead-free materials; and cleaning the sediment and debris from the chiller. Retest water for lead after changes have been made. If levels are still elevated, replacement of the chiller may be necessary.

## Drinking Water Fountain (Water Coolers) (See Exhibit 4.5)

### Example 1:

- Sample 1C (54 ppb) = the plumbing upstream from the cooler and/or the water cooler is contributing lead.
- Sample 3C (40 ppb) exceeds Sample 2C (5 ppb) = the water cooler is contributing 35 ppb of lead.
- Sample 3C (40 ppb) exceeds Sample 2C (5 ppb) and Sample 1C (54 ppb) exceeds Sample 3C (40 ppb) = the plumbing directly upstream from the cooler is contributing 14 ppb of lead.
- Sample 2C (5 ppb) is less than 10 ppb and Sample 2C is less than Sample 1C (54 ppb) and Sample 3C (40 ppb) = the source of lead is not sediments contained in the cooler storage tank, screens, or plumbing upstream from the cooler.

**Possible Solutions:** Replace the cooler with one that contains lead-free components, and retest the water or find an alternative lead-free drinking water source; locate source of lead from plumbing and eliminate it (*routine flushing is not applicable as a potential remedy for water coolers – see discussion of this issue in Sections 5.2 and 5.3 of this guidance document for further information*).

### Example 2:

- Samples 1C (44 ppb), 3C (42 ppb) and 2C (41 ppb) are approximately equal = the cooler is not the likely source of lead.
- Sample 1C (44 ppb) exceeds Sample 3C (42 ppb) and Sample 3C and Sample 2C (41 ppb) are close = the plumbing upstream from the cooler is contributing lead to the water.
- Samples 1C (44 ppb), 3C (42 ppb) and 2C (41 ppb) are approximately equal = the source of lead is not likely sediments contained in the cooler storage tank or screens.
- Sample 4C (43 ppb) significantly exceeds 5 ppb = the source of lead is the plumbing upstream from the cooler.

**Possible Solutions:** Replace the plumbing upstream between the header and cooler with lead-free materials and retest the water. If the water continues to test high, the header, service connection and/or public water supply may be the problem. An evaluation should be made as soon as possible to determine the source of the lead, and other outlets should be tested immediately if not already done. Remember that flushing is not recommended as a practical remedy for water coolers.

## Bottled Water Dispensers (See Exhibit 4.6)

### Example 1:

- Sample 1D (23 ppb) exceeds Sample 2D (5 ppb) = 18 ppb of lead is contributed from the dispenser unit.

**Possible Solution:** Replace dispenser unit with one that is made of lead-free materials and retest.

### Example 2:

- Sample 1D (24 ppb) and Sample 2D (23 ppb) are close = the source of lead is the bottled water.

**Possible Solutions:** Purchase another type of bottled water for which the distributor provides written assurance that lead levels do not exceed federal and state lead standards, or find other alternative lead-free water source. Retest after any remedy has been employed.

## Ice Making Machines (See Exhibit 4.7)

### Example 1:

- Sample 1E is 22 ppb and Sample 2E (6 ppb) is close to 5 ppb = source of the lead (16 ppb) is the ice maker.

**Possible Solutions:** Replace plumbing components in ice maker with lead-free materials; clean debris from plumbing and screen at inlet to ice maker; replace with lead-free ice maker; retest after any remedy has been employed.

### Example 2:

- Sample 1E = 22 ppb and Sample 2E (21 ppb) significantly exceeds 5 ppb = lead is contributed from the plumbing upstream from the ice maker.
- Sample 2E (21 ppb) exceeds 20 ppb = sampling from the distribution system supplying water to the ice maker is recommended (see *Exhibit 4.9 for instructions*).

## Faucets (Taps) (See Exhibit 4.8)

### Example 1:

- Sample 1F (39 ppb) exceeds Sample 2F (6 ppb) = 33 ppb of lead is contributed from the water faucet.
- Sample 2F (6 ppb) is close to 5 ppb = very little lead is coming from the plumbing upstream from the faucet; the majority of the lead is coming from the faucet and/or the plumbing connecting the faucet to the lateral.

**Possible Solutions:** Replace faucet with lead-free device (ensure compliance with the NSF standards for any fixtures you intend to purchase); replace plumbing connecting the faucet to the lateral with lead-free materials; flush outlet and connecting plumbing each day; apply point-of-use device designed to remove lead; find alternative water source such as bottled water or other lead-free location in the building; retest after any remedies are employed.

### Example 2:

- Sample 1F (49 ppb) exceeds Sample 2F (25 ppb) = source of lead (24 ppb) is the water faucet and the plumbing upstream from the outlet (25 ppb).
- Sample 2F (25 ppb) significantly exceeds 5 ppb = lead may be contributed from upstream from the faucet; evaluate lead test results conducted upstream from the faucet to ascertain potential contributions of lead from the upstream piping. To pinpoint location test interior plumbing (see *instructions for sampling interior plumbing in Exhibit 4.9*).

**Possible Solutions:** Replace faucet with lead-free device (ensure compliance with the NSF standards for any fixtures you intend to purchase); replace plumbing connecting faucet to the lateral with lead-free materials; replace suspected portion of interior plumbing with lead-free materials; flush the outlet and interior plumbing each day; apply point-of-use device designed to remove lead; find alternative water source such as bottled water or water from other lead-free location in the building; retest after any remedies are employed.

## Interior Plumbing (See Exhibit 4.9)

### Example 1:

- Sample 1G (22 ppb) exceeds 20 ppb = collect additional samples from the plumbing upstream to further pinpoint the source of lead (i.e., from the service line, the riser pipe, the loop, or the header supplying water to the lateral).
- Sample 1G (22 ppb) significantly exceeds 5 ppb and is less than downstream site (35 ppb) = a portion of the lead (13 ppb) is contributed downstream from the sample site.
- Sample 1G (22 ppb) is not similar to downstream site (35 ppb) but both exceed 20 ppb = lead is contributed from the lateral or from interior plumbing upstream from the lateral; possible sources of lead may be the loop, header, riser pipe, or service connection; further sampling is necessary.

**Possible Solution:** Following the collection of additional samples from plumbing upstream to pinpoint sources of lead, replace plumbing with lead-free materials; retest water for lead.

### Example 2:

- Sample 1H or 1J (23 ppb) exceeds 20 ppb = collect additional samples from the plumbing upstream supplying water to the loop or header; compare the results with those taken from the service line or the riser pipe that supplies water to the loop and/or header.
- Sample 1H or 1J (23 ppb) significantly exceeds 5 ppb and Sample 1H or 1J is less than downstream site (25 ppb) = a small portion of the lead (2 ppb) is contributed downstream of the sample site.

**Possible Solution:** Following the collection of additional samples upstream from the header or loop to pinpoint source of lead, replace affected plumbing with lead-free materials; retest water for lead.

### Example 3:

- Downstream Site is 25 ppb, Service Connection Sample is 4 ppb, and Sample 1J (6 ppb) is less than 20 ppb = additional samples from upstream need not be collected; 21 ppb of lead is contributed from the downstream site.
- Sample 1J (6 ppb) is not equal to downstream site (25 ppb) = source of lead is not the riser pipe or the plumbing and service connection upstream from the riser pipe.
- 1J (6 ppb) is close to 5 ppb = the portion of the riser pipe and plumbing upstream from Sample Site 1J and the service connection are not contributing lead to the water; the source of lead is downstream of the sample site.

**Possible Solution:** Following the collection of samples from interior plumbing downstream from the riser pipe and the affected outlet to pinpoint the source of lead, replace affected plumbing with lead-free materials; retest water for lead.

## Appendix I – Plumbing Profile Questionnaire

This questionnaire is designed to assist with the determination of whether or not lead is likely to be a problem in your facility, and will enable you to prioritize your sampling effort. A separate plumbing profile may be needed for each building, addition, or wing of your facility, especially if the construction took place at different times. Some of the questions in this questionnaire may not apply to your facility for various reasons. Skip those questions that do not apply. For a discussion of this questionnaire and interpretation of possible answers, please see Chapter 3 of the document.

Plumbing Profile Questions	Answers
<p>1. When was the original building constructed?</p> <p>Were any buildings or additions added to the original facility? If so, complete a separate plumbing profile for each building, addition, or wing.</p>	
<p>2. If built or repaired since 1986, were lead-free plumbing and solder used in accordance with the lead-free requirements of the 1986 Safe Drinking Water Act Amendments? What type of solder has been used?</p>	
<p>3. When were the most recent plumbing repairs made (note locations)?</p>	
<p>4. With what materials is the service connection (the pipe that carries water to the school from the public water system's main in the street) made?</p> <p>Note the location where the service connection enters the building and connects to the interior plumbing.</p>	

	<p>5. Specifically, what are the potable water pipes made of in your facility (note the locations)?</p> <ul style="list-style-type: none"> <li>• Lead</li> <li>• Plastic</li> <li>• Galvanized Metal</li> <li>• Cast Iron</li> <li>• Copper</li> <li>• Other</li> </ul> <p>Note the location of the different types of pipe, if applicable, and the direction of water flow through the building. Note the areas of the building that receive water first, and which areas receive water last.</p>
	<p>6. Do you have tanks in your plumbing system (pressure tanks, gravity storage tanks)?</p> <p>Note the location of any tanks, and any available information about the tank; e.g., manufacturer, date of installation.</p>
	<p>7. Was lead solder used in your plumbing system? Note the locations with lead solder.</p>
	<p>8. Are brass fittings, faucets, or valves used in your drinking water system? (Note: Most faucets are brass on the inside.)</p> <p>You may want to note the locations on a map or diagram of your facility and make extensive notes that would facilitate future analysis of lead sample results.</p>



	<p>9. How many of the following outlets provide water for consumption? Note the locations.</p> <ul style="list-style-type: none"> <li>• Water Coolers</li> <li>• Bubblers</li> <li>• Ice Makers</li> <li>• Kitchen Taps</li> <li>• Drinking Fountains or Taps</li> </ul>
	<p>10. Has your school checked the brands and models of water coolers and compared them to the listing of banned water coolers in Appendix E of this document? Note the locations of any banned coolers.</p>
	<p>11. Do outlets that provide drinking water have accessible screens or aerators? (Standard faucets usually have screens. Many coolers and bubblers also have screens.) Note the locations.</p>
	<p>12. Have these screens been cleaned? Note the locations.</p>

<p>13. Can you detect signs of corrosion, such as frequent leaks, rust-colored water, or stained dishes or laundry? Note the locations.</p>	
<p>14. Is any electrical equipment grounded to water pipes? Note the locations.</p>	
<p>15. Have there been any complaints about bad (metallic) taste? Note the locations.</p>	

<p>16. Check building files to determine whether any water samples have been taken from your building for any contaminants (also check with your public water supplier).</p> <ul style="list-style-type: none"> <li>• Name of contaminant(s)?</li> <li>• What concentrations of these contaminants were found?</li> <li>• What was the pH level of the water?</li> <li>• Is testing done regularly at your facility?</li> </ul>	
<p>17. Other plumbing questions:</p> <ul style="list-style-type: none"> <li>• Are blueprints of the building available?</li> <li>• Are there known plumbing “dead-ends,” low use areas, existing leaks or other “problem areas”?</li> <li>• Are renovations being planned for part or all of the plumbing system?</li> </ul>	



